

Tutte le parti di questo catalogo - foto comprese - sono di proprietà Euro-Fer. La riproduzione, anche parziale, è vietata in ogni forma e con ogni mezzo. / Every part of this catalogue - photos included - is Euro-Fer's property. All forms of copying are strictly prohibited.

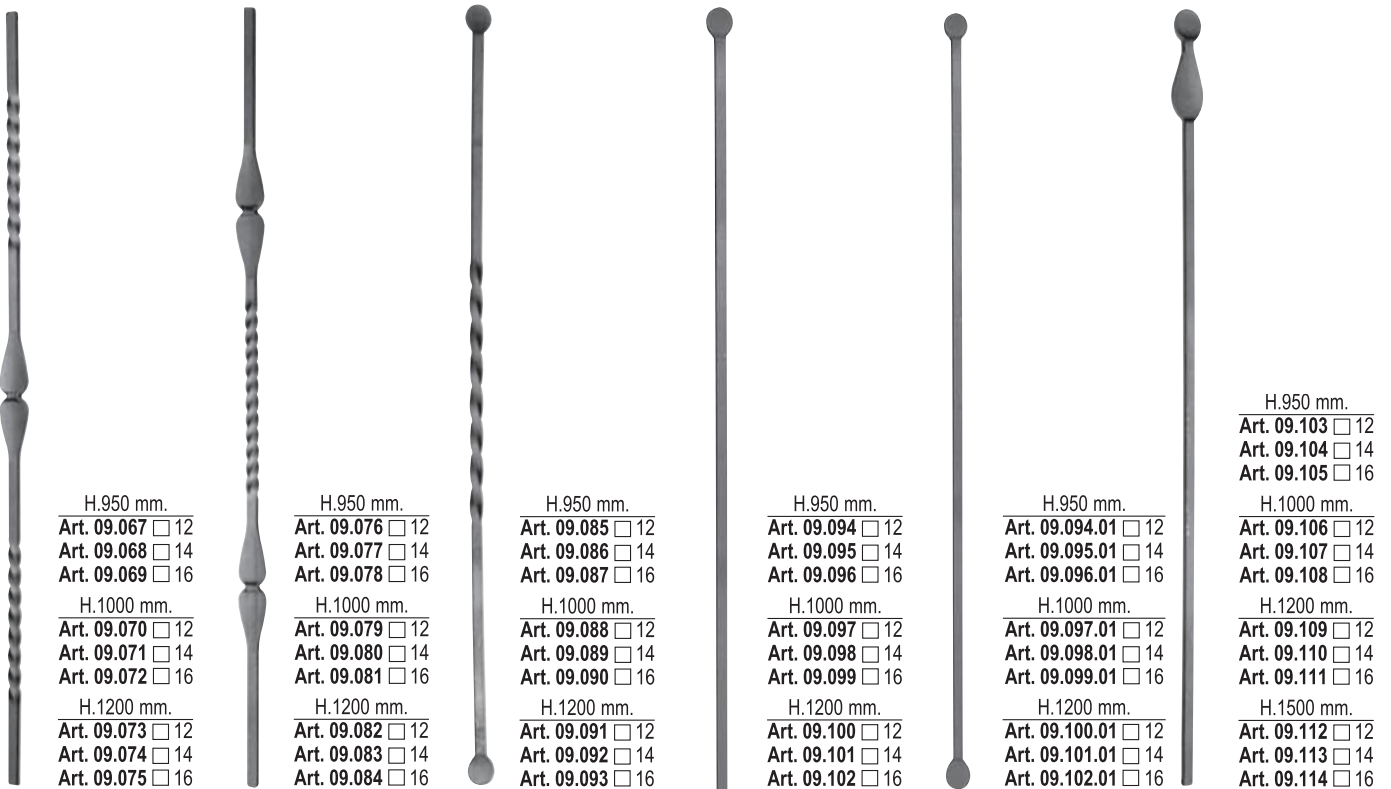

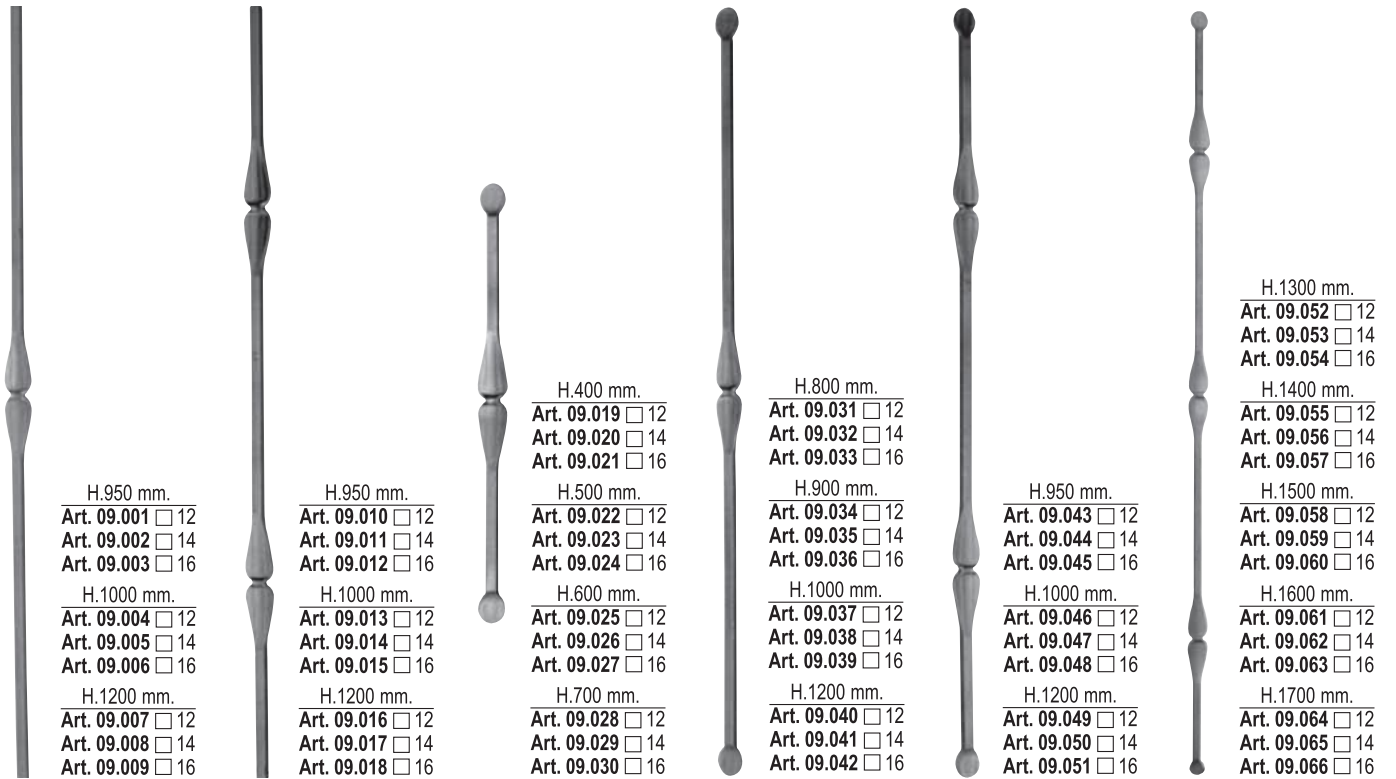

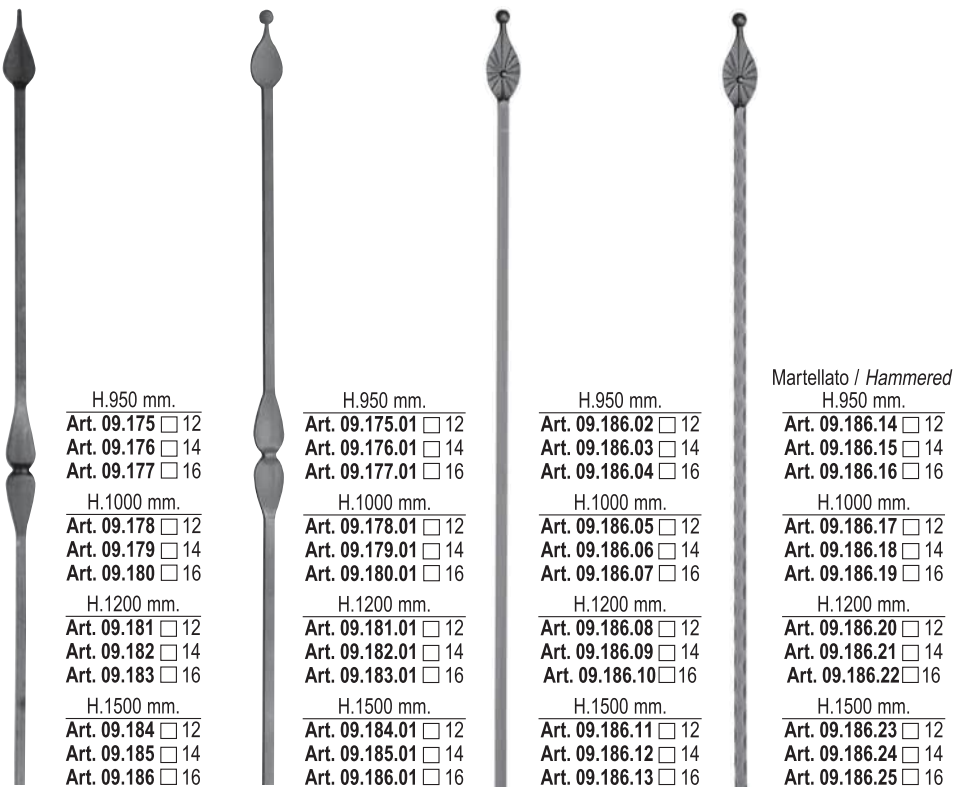
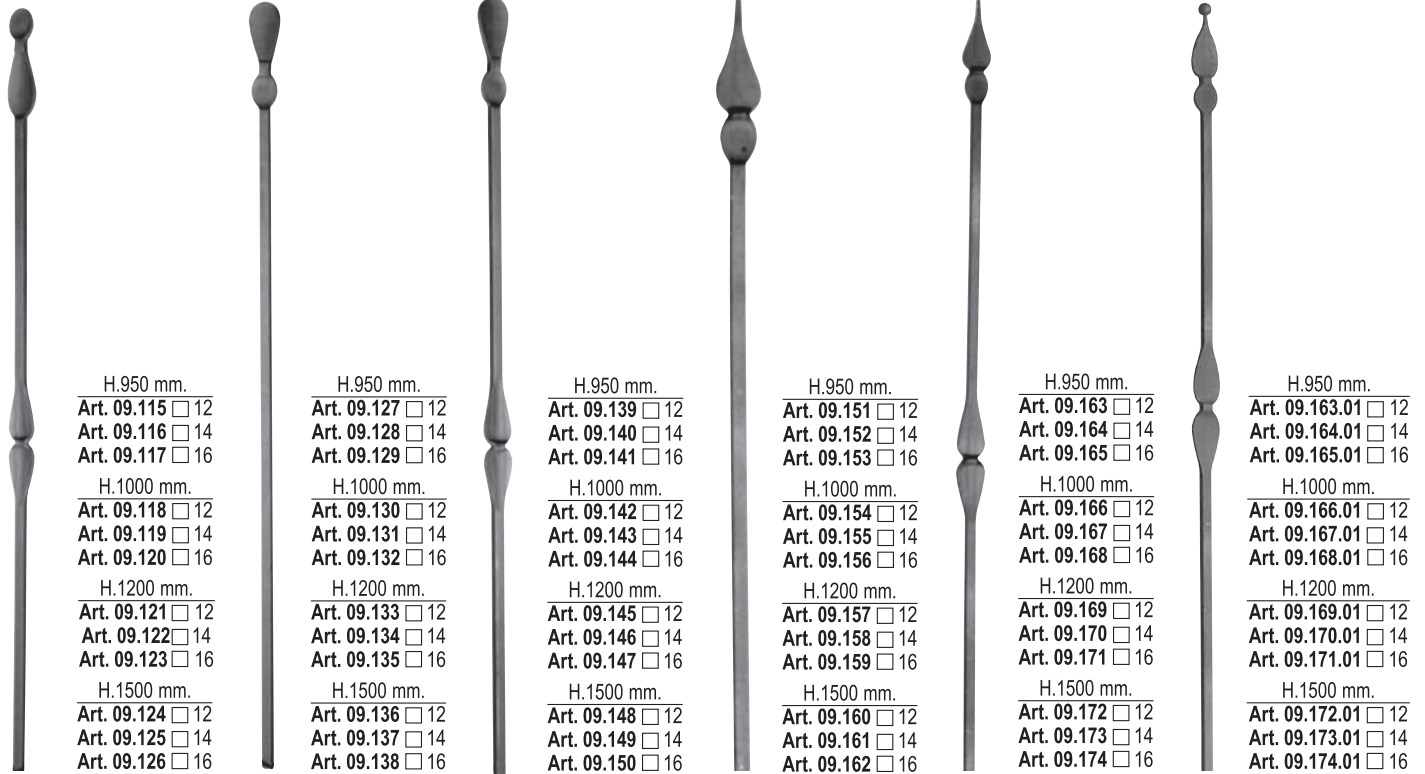
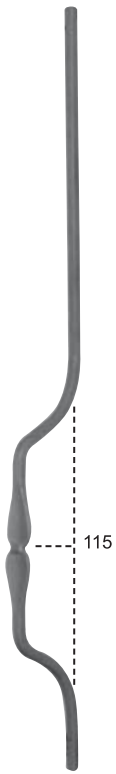

H.950 mm.
Art. 09.187 □ 12
Art. 09.188 □ 14
Art. 09.189 □ 16

H.1000 mm.
Art. 09.190 □ 12
Art. 09.191 □ 14
Art. 09.192 □ 16

H.1200 mm.
Art. 09.193 □ 12
Art. 09.194 □ 14
Art. 09.195 □ 16

H.1500 mm.
Art. 09.196 □ 12
Art. 09.197 □ 14
Art. 09.198 □ 16

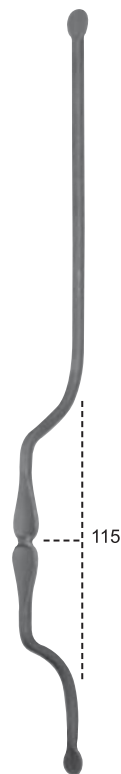

H.950 mm.
Art. 09.199 □ 12
Art. 09.200 □ 14
Art. 09.201 □ 16

H.1000 mm.
Art. 09.202 □ 12
Art. 09.203 □ 14
Art. 09.204 □ 16

H.1200 mm.
Art. 09.205 □ 12
Art. 09.206 □ 14
Art. 09.207 □ 16

H.1500 mm.
Art. 09.208 □ 12
Art. 09.209 □ 14
Art. 09.210 □ 16



H.950 mm.
Art. 09.211 □ 12
Art. 09.212 □ 14
Art. 09.213 □ 16

H.1000 mm.
Art. 09.214 □ 12
Art. 09.215 □ 14
Art. 09.216 □ 16

H.1200 mm.
Art. 09.217 □ 12
Art. 09.218 □ 14
Art. 09.219 □ 16

H.1500 mm. **NEW**
Art. 09.219.20 □ 12
Art. 09.219.21 □ 14

H.2000 mm.
Art. 09.219.63 □ 12
Art. 09.219.65 □ 14



H.1800 mm.
Art. 09.219.50 □ 14
Art. 09.219.51 □ 16

H.2000 mm.
Art. 09.219.52 □ 14
Art. 09.219.53 □ 16



H.950 mm.
Art. 09.220 □ 12
Art. 09.221 □ 14
Art. 09.222 □ 16

H.1000 mm.
Art. 09.223 □ 12
Art. 09.224 □ 14
Art. 09.225 □ 16

H.1200 mm.
Art. 09.226 □ 12
Art. 09.227 □ 14
Art. 09.228 □ 16



H.400 mm.
Art. 09.229 □ 12
Art. 09.230 □ 14
Art. 09.231 □ 16

H.500 mm.
Art. 09.232 □ 12
Art. 09.233 □ 14
Art. 09.234 □ 16

H.600 mm.
Art. 09.235 □ 12
Art. 09.236 □ 14
Art. 09.237 □ 16

H.700 mm.
Art. 09.238 □ 12
Art. 09.239 □ 14
Art. 09.240 □ 16



H.800 mm.
Art. 09.241 □ 12
Art. 09.242 □ 14
Art. 09.243 □ 16

H.900 mm.
Art. 09.244 □ 12
Art. 09.245 □ 14
Art. 09.246 □ 16

H.1000 mm.
Art. 09.247 □ 12
Art. 09.248 □ 14
Art. 09.249 □ 16

H.1200 mm.
Art. 09.250 □ 12
Art. 09.251 □ 14
Art. 09.252 □ 16

H.1400 mm. **NEW**
Art. 09.252.10 □ 14



H.950 mm.
Art. 09.253 □ 12
Art. 09.254 □ 14
Art. 09.255 □ 16

H.1000 mm.
Art. 09.256 □ 12
Art. 09.257 □ 14
Art. 09.258 □ 16

H.1200 mm.
Art. 09.259 □ 12
Art. 09.260 □ 14
Art. 09.261 □ 16

H.1500 mm.
Art. 09.262 □ 12
Art. 09.263 □ 14
Art. 09.264 □ 16

H.1400 mm. **NEW**
Art. 09.264.10 □ 14

H.1800 mm.
Art. 09.264.12 □ 14

H.2000 mm.
Art. 09.264.14 □ 14



H.1300 mm.
Art. 09.265 □ 12
Art. 09.266 □ 14
Art. 09.267 □ 16

H.1400 mm.
Art. 09.268 □ 12
Art. 09.269 □ 14
Art. 09.270 □ 16



H.950 mm.
Art. 09.280 □ 12
Art. 09.281 □ 14
Art. 09.282 □ 16

H.1000 mm.
Art. 09.283 □ 12
Art. 09.284 □ 14
Art. 09.285 □ 16

H.1200 mm.
Art. 09.286 □ 12
Art. 09.287 □ 14
Art. 09.288 □ 16

H.1500 mm.
Art. 09.289 □ 12
Art. 09.290 □ 14
Art. 09.291 □ 16



H.950 mm.
Art. 09.292 □ 12
Art. 09.293 □ 14
Art. 09.294 □ 16

H.1000 mm.
Art. 09.295 □ 12
Art. 09.296 □ 14
Art. 09.297 □ 16

H.1200 mm.
Art. 09.298 □ 12
Art. 09.299 □ 14
Art. 09.300 □ 16

H.1500 mm.
Art. 09.301 □ 12
Art. 09.302 □ 14
Art. 09.303 □ 16

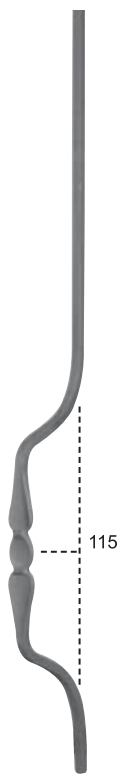

H.950 mm.
Art. 09.304 □ 12
Art. 09.305 □ 14
Art. 09.306 □ 16

H.1000 mm.
Art. 09.307 □ 12
Art. 09.308 □ 14
Art. 09.309 □ 16

H.1200 mm.
Art. 09.310 □ 12
Art. 09.311 □ 14
Art. 09.312 □ 16

H.1500 mm.
Art. 09.313 □ 12
Art. 09.314 □ 14
Art. 09.315 □ 16

H.1800 mm.
Art. 09.316 □ 12
Art. 09.317 □ 14
Art. 09.318 □ 16



H.950 mm.
Art. 09.319 □ 12
Art. 09.320 □ 14
Art. 09.321 □ 16

H.1000 mm.
Art. 09.322 □ 12
Art. 09.323 □ 14
Art. 09.324 □ 16

H.1200 mm.
Art. 09.325 □ 12
Art. 09.326 □ 14
Art. 09.327 □ 16

H.1500 mm.
Art. 09.328 □ 12
Art. 09.329 □ 14
Art. 09.330 □ 16

H.1800 mm.
Art. 09.331 □ 12
Art. 09.332 □ 14
Art. 09.333 □ 16



H.950 mm.
Art. 09.334 □ 12
Art. 09.335 □ 14
Art. 09.336 □ 16

H.1000 mm.
Art. 09.337 □ 12
Art. 09.338 □ 14
Art. 09.339 □ 16

H.1200 mm.
Art. 09.340 □ 12
Art. 09.341 □ 14
Art. 09.342 □ 16

H.1500 mm.
Art. 09.343 □ 12
Art. 09.344 □ 14
Art. 09.345 □ 16

H.1800 mm.
Art. 09.346 □ 12
Art. 09.347 □ 14
Art. 09.348 □ 16



H.900 mm. **NEW**
Art. 09.348.50 □ 12
Art. 09.348.51 □ 14

H.950 mm.
Art. 09.349 □ 12
Art. 09.350 □ 14
Art. 09.351 □ 16

H.1000 mm.
Art. 09.352 □ 12
Art. 09.353 □ 14
Art. 09.354 □ 16

H.1200 mm.
Art. 09.355 □ 12
Art. 09.356 □ 14
Art. 09.357 □ 16

H.1400 mm. **NEW**
Art. 09.363.20 □ 14

H.1500 mm.
Art. 09.358 □ 12
Art. 09.359 □ 14
Art. 09.360 □ 16

H.1800 mm.
Art. 09.361 □ 12
Art. 09.362 □ 14
Art. 09.363 □ 16

H.1600 mm. **NEW**
Art. 09.363.23 □ 14

H.1700 mm.
Art. 09.363.26 □ 14

H.1800 mm.
Art. 09.363.29 □ 14



H.950 mm.
Art. 09.364 □ 12
Art. 09.365 □ 14
Art. 09.366 □ 16

H.1000 mm.
Art. 09.367 □ 12
Art. 09.368 □ 14
Art. 09.369 □ 16

H.1200 mm.
Art. 09.370 □ 12
Art. 09.371 □ 14
Art. 09.372 □ 16

H.1500 mm.
Art. 09.373 □ 12
Art. 09.374 □ 14
Art. 09.375 □ 16

H.1800 mm.
Art. 09.376 □ 12
Art. 09.377 □ 14



H.950 mm.
Art. 09.379 □ 12
Art. 09.380 □ 14
Art. 09.381 □ 16

H.1000 mm.
Art. 09.382 □ 12
Art. 09.383 □ 14
Art. 09.384 □ 16

H.1200 mm.
Art. 09.385 □ 12
Art. 09.386 □ 14
Art. 09.387 □ 16

H.1500 mm.
Art. 09.388 □ 12
Art. 09.389 □ 14
Art. 09.390 □ 16

H.1800 mm.
Art. 09.391 □ 12
Art. 09.392 □ 14
Art. 09.393 □ 16



H.950 mm.
Art. 09.394 □ 12
Art. 09.395 □ 14
Art. 09.396 □ 16

H.1000 mm.
Art. 09.397 □ 12
Art. 09.398 □ 14
Art. 09.399 □ 16

H.1200 mm.
Art. 09.400 □ 12
Art. 09.401 □ 14
Art. 09.402 □ 16

H.1500 mm.
Art. 09.403 □ 12
Art. 09.404 □ 14
Art. 09.405 □ 16



H.950 mm.
Art. 09.406 □ 12
Art. 09.407 □ 14
Art. 09.408 □ 16

H.1000 mm.
Art. 09.409 □ 12
Art. 09.410 □ 14
Art. 09.411 □ 16

H.1200 mm.
Art. 09.412 □ 12
Art. 09.413 □ 14
Art. 09.414 □ 16

H.1500 mm.
Art. 09.415 □ 12
Art. 09.416 □ 14
Art. 09.417 □ 16



H.950 mm.
Art. 09.418 □ 12
Art. 09.419 □ 14
Art. 09.420 □ 16

H.1000 mm.
Art. 09.421 □ 12
Art. 09.422 □ 14
Art. 09.423 □ 16

H.1200 mm.
Art. 09.424 □ 12
Art. 09.425 □ 14
Art. 09.426 □ 16

H.1500 mm.
Art. 09.427 □ 12
Art. 09.428 □ 14
Art. 09.429 □ 16



H.950 mm.
Art. 09.430 □ 12
Art. 09.431 □ 14
Art. 09.432 □ 16

H.1000 mm.
Art. 09.433 □ 12
Art. 09.434 □ 14
Art. 09.435 □ 16

H.1200 mm.
Art. 09.436 □ 12
Art. 09.437 □ 14
Art. 09.438 □ 16

H.1500 mm.
Art. 09.439 □ 12
Art. 09.440 □ 14
Art. 09.441 □ 16



H.950 mm.
Art. 09.442 □ 12
Art. 09.443 □ 14
Art. 09.444 □ 16

H.1000 mm.
Art. 09.445 □ 12
Art. 09.446 □ 14
Art. 09.447 □ 16

H.1200 mm.
Art. 09.448 □ 12
Art. 09.449 □ 14
Art. 09.450 □ 16

H.1500 mm.
Art. 09.451 □ 12
Art. 09.452 □ 14
Art. 09.453 □ 16



H.950 mm.
Art. 09.442.01 □ 12
Art. 09.443.01 □ 14
Art. 09.444.01 □ 16

H.1000 mm.
Art. 09.445.01 □ 12
Art. 09.446.01 □ 14
Art. 09.447.01 □ 16

H.1200 mm.
Art. 09.448.01 □ 12
Art. 09.449.01 □ 14
Art. 09.450.01 □ 16

H.1500 mm.
Art. 09.451.01 □ 12
Art. 09.452.01 □ 14
Art. 09.453.01 □ 16



H.950 mm.
Art. 09.454 □ 12
Art. 09.455 □ 14
Art. 09.456 □ 16

H.1000 mm.
Art. 09.457 □ 12
Art. 09.458 □ 14
Art. 09.459 □ 16

H.1200 mm.
Art. 09.460 □ 12
Art. 09.461 □ 14
Art. 09.462 □ 16

H.1500 mm.
Art. 09.463 □ 12
Art. 09.464 □ 14
Art. 09.465 □ 16



H.950 mm.
Art. 09.454.01 □ 12
Art. 09.455.01 □ 14
Art. 09.456.01 □ 16

H.1000 mm.
Art. 09.457.01 □ 12
Art. 09.458.01 □ 14
Art. 09.459.01 □ 16

H.1200 mm.
Art. 09.460.01 □ 12
Art. 09.461.01 □ 14
Art. 09.462.01 □ 16

H.1500 mm.
Art. 09.463.01 □ 12
Art. 09.464.01 □ 14
Art. 09.465.01 □ 16



H.950 X L.175 mm.
Art. 09.466
□ 12 ≧ 12 X 6



H.950 X L.175 mm.
Art. 09.467
□ 12 ≧ 12 X 6



H.950 X L.150 mm.
Art. 09.468
□ 12 ≧ 12 X 6



Martel. / Hammered
H.950 mm.
Art. 09.468.01 □ 12
Art. 09.468.02 □ 14
Art. 09.468.03 □ 16

H.1000 mm.
Art. 09.468.04 □ 12
Art. 09.468.05 □ 14
Art. 09.468.06 □ 16

H.1200 mm.
Art. 09.468.07 □ 12
Art. 09.468.08 □ 14
Art. 09.468.09 □ 16

H.1500 mm.
Art. 09.468.10 □ 12
Art. 09.468.11 □ 14
Art. 09.468.12 □ 16



Martel. / Hammered
H.950 mm.
Art. 09.468.13 □ 12
Art. 09.468.14 □ 14
Art. 09.468.15 □ 16

H.1000 mm.
Art. 09.468.16 □ 12
Art. 09.468.17 □ 14
Art. 09.468.18 □ 16

H.1200 mm.
Art. 09.468.19 □ 12
Art. 09.468.20 □ 14
Art. 09.468.21 □ 16

H.1500 mm.
Art. 09.468.22 □ 12
Art. 09.468.23 □ 14
Art. 09.468.24 □ 16

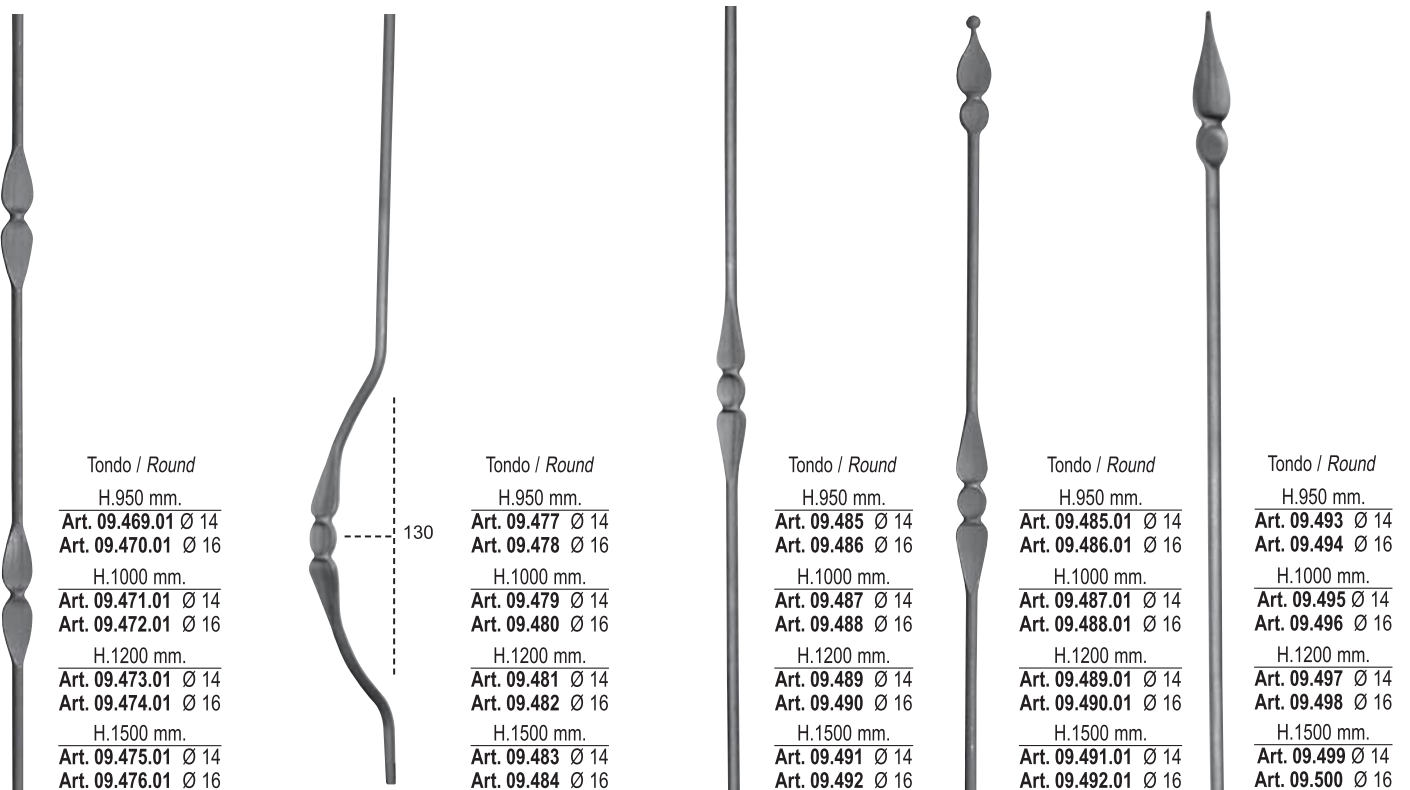
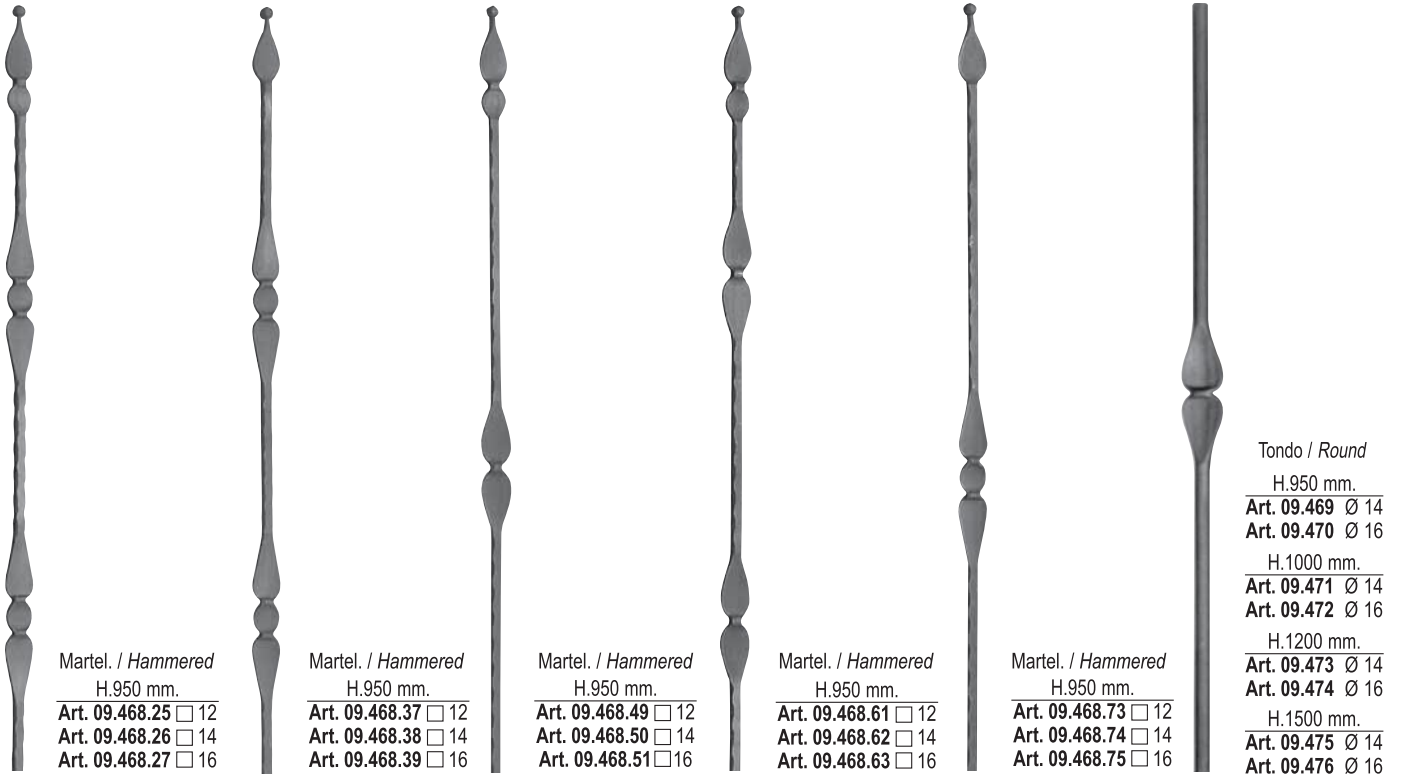



Tondo / Round

H.950 mm.

Art. 09.493.01 Ø 14

Art. 09.494.01 Ø 16

H.1000 mm.

Art. 09.495.01 Ø 14

Art. 09.496.01 Ø 16

H.1200 mm.

Art. 09.497.01 Ø 14

Art. 09.498.01 Ø 16

H.1500 mm.

Art. 09.499.01 Ø 14

Art. 09.500.01 Ø 16



Fiamma grande / Big flame



Tondo / Round

H.950 mm.

Art. 09.500.20 Ø12

H.1000 mm.

Art. 09.500.23 Ø12

H.950 mm.

Art. 09.500.30 □ 12

H.1000 mm.

Art. 09.500.33 □ 12



Tondo / Round

H.950 mm.

Art. 09.501 Ø 14

Art. 09.502 Ø 16

H.1000 mm.

Art. 09.503 Ø 14

Art. 09.504 Ø 16

H.1200 mm.

Art. 09.505 Ø 14

Art. 09.506 Ø 16

H.1500 mm.

Art. 09.507 Ø 14

Art. 09.508 Ø 16



Tondo / Round

Borchia tornita / Turned stud

H.950 mm.

Art. 09.509 Ø 14

Art. 09.509.01 Ø 12

Borchia stampata / Stamped stud

H.950 mm.

Art. 09.509.02 Ø 14

Art. 09.509.03 Ø 12



550



Tondo / Round

Borchia tornita / Turned stud

H.950 mm.

Art. 09.510 Ø 14

Art. 09.510.07 Ø 12

Borchia stampata / Stamped stud

H.950 mm.

Art. 09.510.10 Ø 14

Art. 09.510.12 Ø 12



H.950 mm.

Art. 09.510.03 □ 14

Art. 09.510.05 □ 12



H.950 mm.

Art. 09.510.04 □ 14

Art. 09.510.06 □ 12



H.1500 mm.

Art. 09.510.08 □ 12

Art. 09.510.09 □ 14



H.2000 mm.

Art. 09.510.20 □ 12

Art. 09.510.21 □ 14



H.950 mm.
Art. 09.510.22 Ø 14



H.950 mm.
Art. 09.510.23 Ø 14



H.950 mm.
Art. 09.511 Ø12
H.1000 mm.
Art. 09.512 Ø12
H.1200 mm.
Art. 09.513 Ø12



H.950 mm.
Art. 09.514 Ø12
H.1000 mm.
Art. 09.515 Ø12
H.1200 mm.
Art. 09.516 Ø12

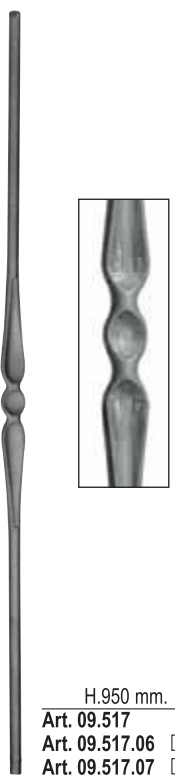

H.950 mm.
Art. 09.517 Ø14
Art. 09.517.06 □12
Art. 09.517.07 □14



H.950 mm.
Art. 09.517.01 Ø14
Art. 09.517.08 □12
Art. 09.517.09 □14

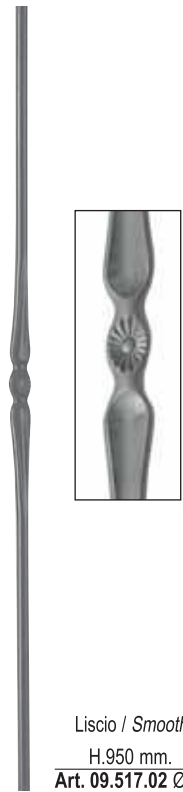

Liscio / Smooth
H.950 mm.
Art. 09.517.02 Ø14



Liscio / Smooth
H.950 mm.
Art. 09.517.03 Ø14



Liscio / Smooth
H.950 mm
Art. 09.517.04 Ø 14

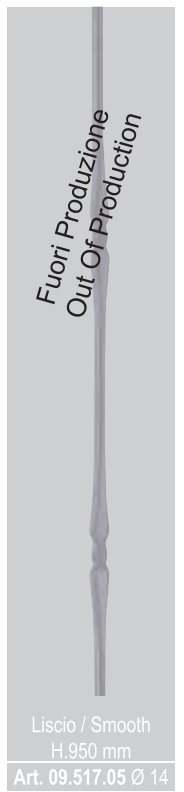

Liscio / Smooth
H.950 mm
Art. 09.517.05 Ø 14

↑ ↑ articoli sostituiti da 09.517.02 e 09.517.03



Martellato / Hammered

H.950 mm.
Art. 09.518 □ 12
Art. 09.519 □ 14
Art. 09.520 □ 16
H.1000 mm.
Art. 09.521 □ 12
Art. 09.522 □ 14
Art. 09.523 □ 16
H.1200 mm.
Art. 09.524 □ 12
Art. 09.525 □ 14
Art. 09.526 □ 16



Martellato / Hammered

H.950 mm.
Art. 09.518.01 □ 12
Art. 09.519.01 □ 14
Art. 09.520.01 □ 16
H.1000 mm.
Art. 09.521.01 □ 12
Art. 09.522.01 □ 14
Art. 09.523.01 □ 16
H.1200 mm.
Art. 09.524.01 □ 12
Art. 09.525.01 □ 14
Art. 09.526.01 □ 16



Martellato / Hammered

H.950 mm.
Art. 09.527 □ 12
Art. 09.528 □ 14
Art. 09.529 □ 16
H.1000 mm.
Art. 09.530 □ 12
Art. 09.531 □ 14
Art. 09.532 □ 16
H.1200 mm.
Art. 09.533 □ 12
Art. 09.534 □ 14
Art. 09.535 □ 16



Martellato / Hammered

H.950 mm.
Art. 09.536 □ 12
Art. 09.537 □ 14
Art. 09.538 □ 16
H.1000 mm.
Art. 09.539 □ 12
Art. 09.540 □ 14
Art. 09.541 □ 16
H.1200 mm.
Art. 09.542 □ 12
Art. 09.543 □ 14
Art. 09.544 □ 16



Martellato / Hammered

H.950 mm.
Art. 09.536.01 □ 12
Art. 09.537.01 □ 14
Art. 09.538.01 □ 16



Martellato / Hammered

H.950 mm.
Art. 09.545 □ 12
Art. 09.546 □ 14
Art. 09.547 □ 16
H.1000 mm.
Art. 09.548 □ 12
Art. 09.549 □ 14
Art. 09.550 □ 16
H.1200 mm.
Art. 09.551 □ 12
Art. 09.552 □ 14
Art. 09.553 □ 16



Martellato / Hammered

H.950 mm.
Art. 09.545.01 □ 12
Art. 09.546.01 □ 14
Art. 09.547.01 □ 16



Martellato / Hammered

H.950 mm.
Art. 09.554 □ 12
Art. 09.555 □ 14
Art. 09.556 □ 16
H.1000 mm.
Art. 09.557 □ 12
Art. 09.558 □ 14
Art. 09.559 □ 16
H.1200 mm.
Art. 09.560 □ 12
Art. 09.561 □ 14
Art. 09.562 □ 16



130

Martellato / Hammered

H.950 mm.
Art. 09.563 □ 12
Art. 09.564 □ 14
Art. 09.565 □ 16
H.1000 mm.
Art. 09.566 □ 12
Art. 09.567 □ 14
Art. 09.568 □ 16
H.1200 mm.
Art. 09.569 □ 12
Art. 09.570 □ 14
Art. 09.571 □ 16



Martellato / Hammered

H.950 mm.
Art. 09.572 □ 12
Art. 09.573 □ 14
Art. 09.574 □ 16
H.1000 mm.
Art. 09.575 □ 12
Art. 09.576 □ 14
Art. 09.577 □ 16
H.1200 mm.
Art. 09.578 □ 12
Art. 09.579 □ 14
Art. 09.580 □ 16



H.950 mm.
Art. 09.581 □ 12
Art. 09.582 □ 14
Art. 09.583 □ 16
H.1000 mm.
Art. 09.584 □ 12
Art. 09.585 □ 14
Art. 09.586 □ 16
H.1200 mm.
Art. 09.587 □ 12
Art. 09.588 □ 14
Art. 09.589 □ 16



H.950 mm.
Art. 09.608 □ 12
Art. 09.609 □ 14

H.1000 mm.
Art. 09.610 □ 12
Art. 09.611 □ 14

H.1200 mm.
Art. 09.612 □ 12
Art. 09.613 □ 14



H.950 mm.
Art. 09.614 □ 12
Art. 09.615 □ 14

H.1000 mm.
Art. 09.616 □ 12
Art. 09.617 □ 14

H.1200 mm.
Art. 09.618 □ 12
Art. 09.619 □ 14



130

H.950 mm.
Art. 09.620 □ 12
Art. 09.621 □ 14

H.1000 mm.
Art. 09.622 □ 12
Art. 09.623 □ 14

H.1200 mm.
Art. 09.624 □ 12
Art. 09.625 □ 14



100

H.950 mm.
Art. 09.625.01 □ 12
Art. 09.625.02 □ 14



100

100

H.950 mm.
Art. 09.625.03 □ 12
Art. 09.625.04 □ 14



Martellato / Hammered
H.950 mm
Art. 09.625.05 Ø 14 mm



Martellato / Hammered
H.950 mm
Art. 09.625.06 Ø 14 mm



300

H.950 mm.
Art. 09.626 □ 12
Art. 09.627 □ 14

H.1200 mm.
Art. 09.627.01 □ 12
Art. 09.627.02 □ 14

H.1500 mm.
Art. 09.627.03 □ 12
Art. 09.627.04 □ 14



160

H.950 mm.
Art. 09.628 □ 12
Art. 09.629 □ 14

H.1200 mm.
Art. 09.629.01 □ 12
Art. 09.629.02 □ 14

H.1500 mm.
Art. 09.629.03 □ 12
Art. 09.629.04 □ 14



160

H.950 mm.
Art. 09.630
□ 12 ≙ 12 X 6
Art. 09.630.01
□ 14 ≙ 14 X 6

H.1200 mm.
Art. 09.630.02
□ 12 ≙ 12 X 6
Art. 09.630.03
□ 14 ≙ 14 X 6

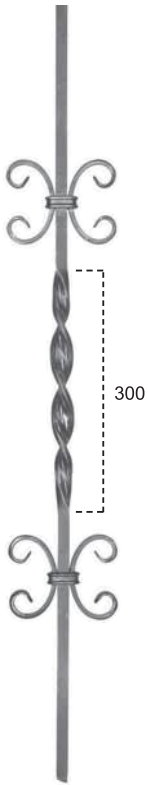

- H.950 mm.
Art. 09.631
 12 \neq 12 X 6
Art. 09.631.01
 14 \neq 14 X 6
- H.1200 mm.
Art. 09.631.02
 12 \neq 12 X 6
Art. 09.631.03
 14 \neq 14 X 6

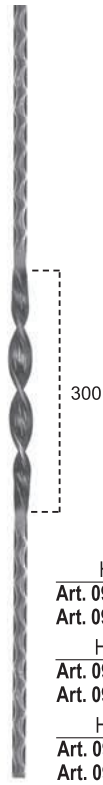

- H.950 mm.
Art. 09.631.04 12
Art. 09.631.05 14
- H.1200 mm.
Art. 09.631.06 12
Art. 09.631.07 14
- H.1500 mm.
Art. 09.631.08 12
Art. 09.631.09 14



- H.950 mm.
Art. 09.631.10 12
Art. 09.631.11 14
- H.1200 mm.
Art. 09.631.12 12
Art. 09.631.13 14
- H.1500 mm.
Art. 09.631.14 12
Art. 09.631.15 14



- H.950 mm.
Art. 09.631.16
 12 \neq 12 X 6
Art. 09.631.17
 14 \neq 14 X 6
- H.1200 mm.
Art. 09.631.18
 12 \neq 12 X 6
Art. 09.631.19
 14 \neq 14 X 6

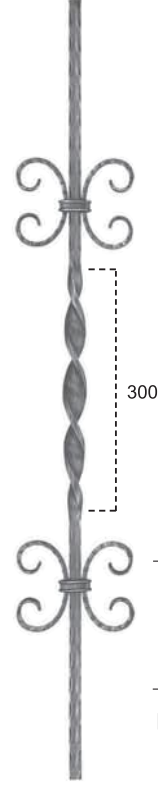

- H.950 mm.
Art. 09.631.20
 12 \neq 12 X 6
Art. 09.631.21
 14 \neq 14 X 6
- H.1200 mm.
Art. 09.631.22
 12 \neq 12 X 6
Art. 09.631.23
 14 \neq 14 X 6

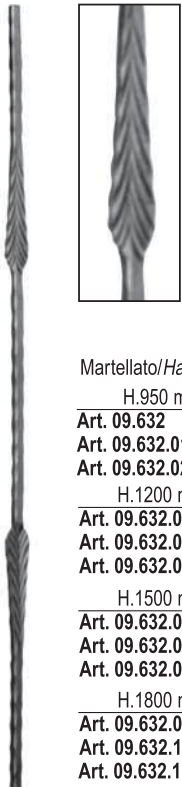

- Martellato/Hammered*
- H.950 mm.
Art. 09.632 12
Art. 09.632.01 14
Art. 09.632.02 16
- H.1200 mm.
Art. 09.632.03 12
Art. 09.632.04 14
Art. 09.632.05 16
- H.1500 mm.
Art. 09.632.06 12
Art. 09.632.07 14
Art. 09.632.08 16
- H.1800 mm.
Art. 09.632.09 12
Art. 09.632.10 14
Art. 09.632.11 16

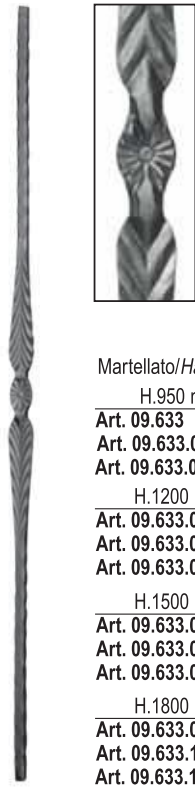

- Martellato/Hammered*
- H.950 mm.
Art. 09.633 12
Art. 09.633.01 14
Art. 09.633.02 16
- H.1200 mm.
Art. 09.633.03 12
Art. 09.633.04 14
Art. 09.633.05 16
- H.1500 mm.
Art. 09.633.06 12
Art. 09.633.07 14
Art. 09.633.08 16
- H.1800 mm.
Art. 09.633.09 12
Art. 09.633.10 14
Art. 09.633.11 16

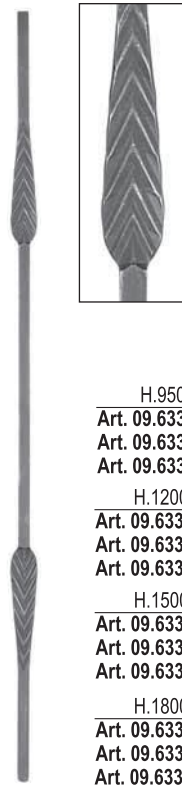

- H.950 mm.
Art. 09.633.12 12
Art. 09.633.13 14
Art. 09.633.14 16
- H.1200 mm.
Art. 09.633.15 12
Art. 09.633.16 14
Art. 09.633.17 16
- H.1500 mm.
Art. 09.633.18 12
Art. 09.633.19 14
Art. 09.633.20 16
- H.1800 mm.
Art. 09.633.21 12
Art. 09.633.22 14
Art. 09.633.23 16

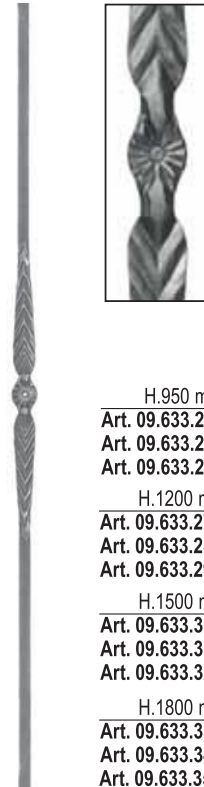

- H.950 mm.
Art. 09.633.24 12
Art. 09.633.25 14
Art. 09.633.26 16
- H.1200 mm.
Art. 09.633.27 12
Art. 09.633.28 14
Art. 09.633.29 16
- H.1500 mm.
Art. 09.633.30 12
Art. 09.633.31 14
Art. 09.633.32 16
- H.1800 mm.
Art. 09.633.33 12
Art. 09.633.34 14
Art. 09.633.35 16



Martellato/Hammered
H.1000 X L.140 mm.
Art. 09.634 12
Art. 09.635 14



Martellato/Hammered
H.1000 X L.140 mm.
Art. 09.636 12
Art. 09.637 14



Martellato/Hammered
H.1000 X L.140 mm.
Art. 09.638 12
Art. 09.639 14



Martellato/Hammered
H.950 mm.
Art. 09.640 12
Art. 09.641 14
Art. 09.642 16
H.1000 mm.
Art. 09.643 12
Art. 09.644 14
Art. 09.645 16
H.1200 mm.
Art. 09.646 12
Art. 09.647 14
Art. 09.648 16

Paletti ricalcati / New forged bars



Martellato/Hammered
H.950 mm.
Art. 09.658 12
Art. 09.659 14



Martellato/Hammered
H.950 mm.
Art. 09.660 12
Art. 09.661 14



H.950 mm.
Art. 09.662 12
Art. 09.663 14



H.950 mm.
Art. 09.664 12
Art. 09.665 14



H.950 X L.200mm.
Art. 09.666 Ø14



H.950 X L.200mm.
Art. 09.667 Ø14



Martellato. / *Hammered*

H. 950 X L. 130 mm.

Art. 09.668 12

Art. 09.669 14

Art. 09.669.01 16

H. 1200 X L. 130 mm.

Art. 09.669.02 12

Art. 09.669.03 14

Art. 09.669.04 16

H. 1500 X L. 130 mm.

Art. 09.669.05 12

Art. 09.669.06 14

Art. 09.669.07 16

H. 1800 X L. 130 mm.

Art. 09.669.08 12

Art. 09.669.09 14

Art. 09.669.10 16



H. 950 X L. 130 mm.

Art. 09.671.01 Ø 14



H.950 mm.

Art. 09.672 12

Art. 09.673 14

Art. 09.674 16



H.950 mm.

Art. 09.684 12

Art. 09.685 14

Art. 09.686 16



H.950 mm.

Art. 09.696 12

Art. 09.697 14

Art. 09.698 16



H.950 mm.

Art. 09.708 12

Art. 09.709 14

Art. 09.710 16

H.1200 mm.

Art. 09.711 12

Art. 09.712 14

Art. 09.713 16

H.1500 mm.

Art. 09.714 12

Art. 09.715 14

Art. 09.716 16

H.1800 mm.

Art. 09.717 12

Art. 09.718 14

Art. 09.719 16



Martel. / *Hammered*

H.950 mm.

Art. 09.720 12

Art. 09.721 14

Art. 09.722 16

H.1200 mm.

Art. 09.723 12

Art. 09.724 14

Art. 09.725 16

H.1500 mm.

Art. 09.726 12

Art. 09.727 14

Art. 09.728 16

H.1800 mm.

Art. 09.729 12

Art. 09.730 14

Art. 09.731 16



H.950 mm.

Art. 09.732 Ø 14

Art. 09.733 Ø 16

H.1200 mm.

Art. 09.734 Ø 14

Art. 09.735 Ø 16

H.1500 mm.

Art. 09.736 Ø 14

Art. 09.737 Ø 16

H.1800 mm.

Art. 09.738 Ø 14

Art. 09.739 Ø 16

Palline piccole / *Small Balls*



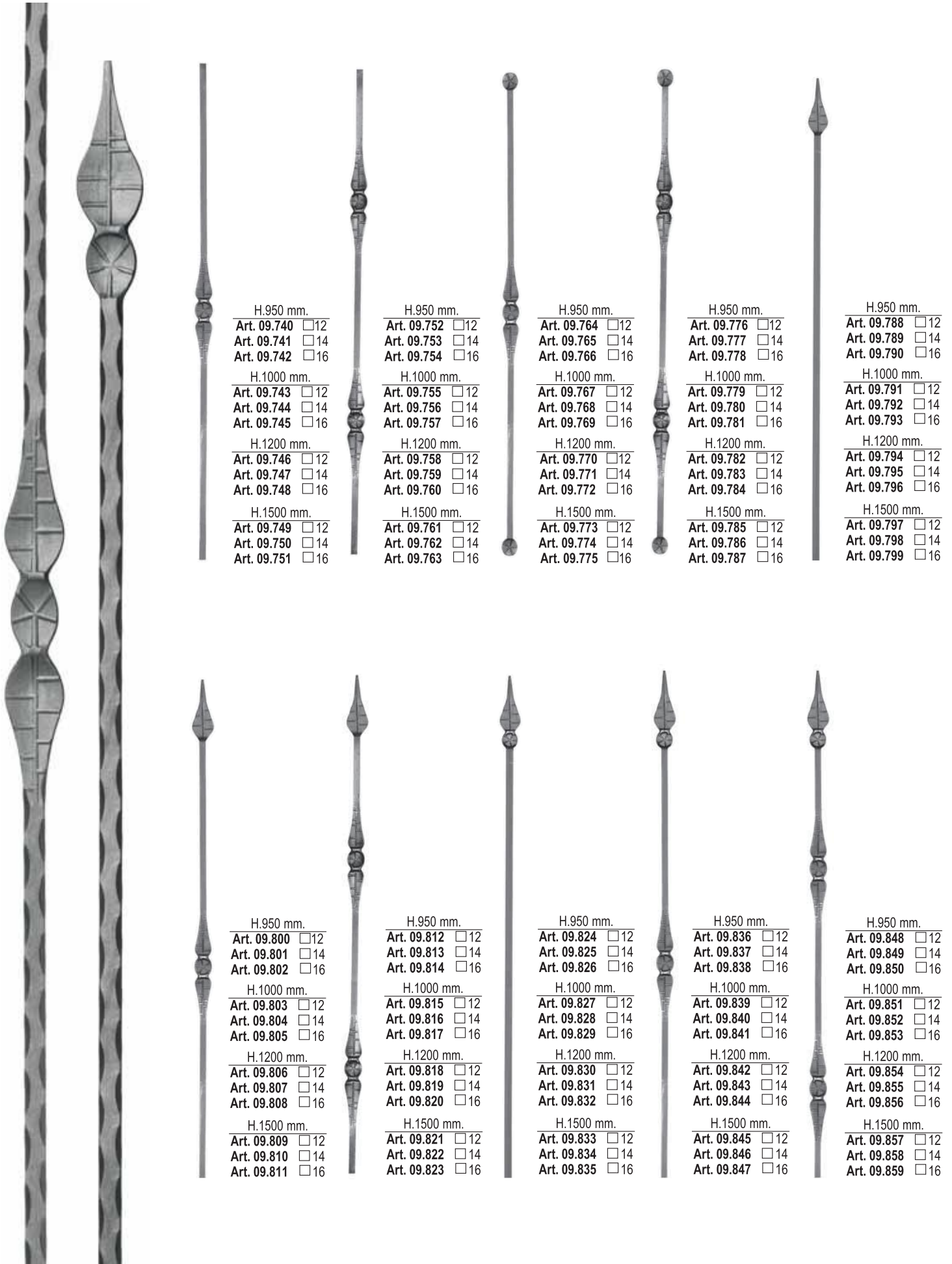

H.950 mm.
Art. 09.740 12
Art. 09.741 14
Art. 09.742 16

H.1000 mm.
Art. 09.743 12
Art. 09.744 14
Art. 09.745 16

H.1200 mm.
Art. 09.746 12
Art. 09.747 14
Art. 09.748 16

H.1500 mm.
Art. 09.749 12
Art. 09.750 14
Art. 09.751 16

H.950 mm.
Art. 09.752 12
Art. 09.753 14
Art. 09.754 16

H.1000 mm.
Art. 09.755 12
Art. 09.756 14
Art. 09.757 16

H.1200 mm.
Art. 09.758 12
Art. 09.759 14
Art. 09.760 16

H.1500 mm.
Art. 09.761 12
Art. 09.762 14
Art. 09.763 16

H.950 mm.
Art. 09.764 12
Art. 09.765 14
Art. 09.766 16

H.1000 mm.
Art. 09.767 12
Art. 09.768 14
Art. 09.769 16

H.1200 mm.
Art. 09.770 12
Art. 09.771 14
Art. 09.772 16

H.1500 mm.
Art. 09.773 12
Art. 09.774 14
Art. 09.775 16

H.950 mm.
Art. 09.776 12
Art. 09.777 14
Art. 09.778 16

H.1000 mm.
Art. 09.779 12
Art. 09.780 14
Art. 09.781 16

H.1200 mm.
Art. 09.782 12
Art. 09.783 14
Art. 09.784 16

H.1500 mm.
Art. 09.785 12
Art. 09.786 14
Art. 09.787 16

H.950 mm.
Art. 09.788 12
Art. 09.789 14
Art. 09.790 16

H.1000 mm.
Art. 09.791 12
Art. 09.792 14
Art. 09.793 16

H.1200 mm.
Art. 09.794 12
Art. 09.795 14
Art. 09.796 16

H.1500 mm.
Art. 09.797 12
Art. 09.798 14
Art. 09.799 16

H.950 mm.
Art. 09.800 12
Art. 09.801 14
Art. 09.802 16

H.1000 mm.
Art. 09.803 12
Art. 09.804 14
Art. 09.805 16

H.1200 mm.
Art. 09.806 12
Art. 09.807 14
Art. 09.808 16

H.1500 mm.
Art. 09.809 12
Art. 09.810 14
Art. 09.811 16

H.950 mm.
Art. 09.812 12
Art. 09.813 14
Art. 09.814 16

H.1000 mm.
Art. 09.815 12
Art. 09.816 14
Art. 09.817 16

H.1200 mm.
Art. 09.818 12
Art. 09.819 14
Art. 09.820 16

H.1500 mm.
Art. 09.821 12
Art. 09.822 14
Art. 09.823 16

H.950 mm.
Art. 09.824 12
Art. 09.825 14
Art. 09.826 16

H.1000 mm.
Art. 09.827 12
Art. 09.828 14
Art. 09.829 16

H.1200 mm.
Art. 09.830 12
Art. 09.831 14
Art. 09.832 16

H.1500 mm.
Art. 09.833 12
Art. 09.834 14
Art. 09.835 16

H.950 mm.
Art. 09.836 12
Art. 09.837 14
Art. 09.838 16

H.1000 mm.
Art. 09.839 12
Art. 09.840 14
Art. 09.841 16

H.1200 mm.
Art. 09.842 12
Art. 09.843 14
Art. 09.844 16

H.1500 mm.
Art. 09.845 12
Art. 09.846 14
Art. 09.847 16

H.950 mm.
Art. 09.848 12
Art. 09.849 14
Art. 09.850 16

H.1000 mm.
Art. 09.851 12
Art. 09.852 14
Art. 09.853 16

H.1200 mm.
Art. 09.854 12
Art. 09.855 14
Art. 09.856 16

H.1500 mm.
Art. 09.857 12
Art. 09.858 14
Art. 09.859 16

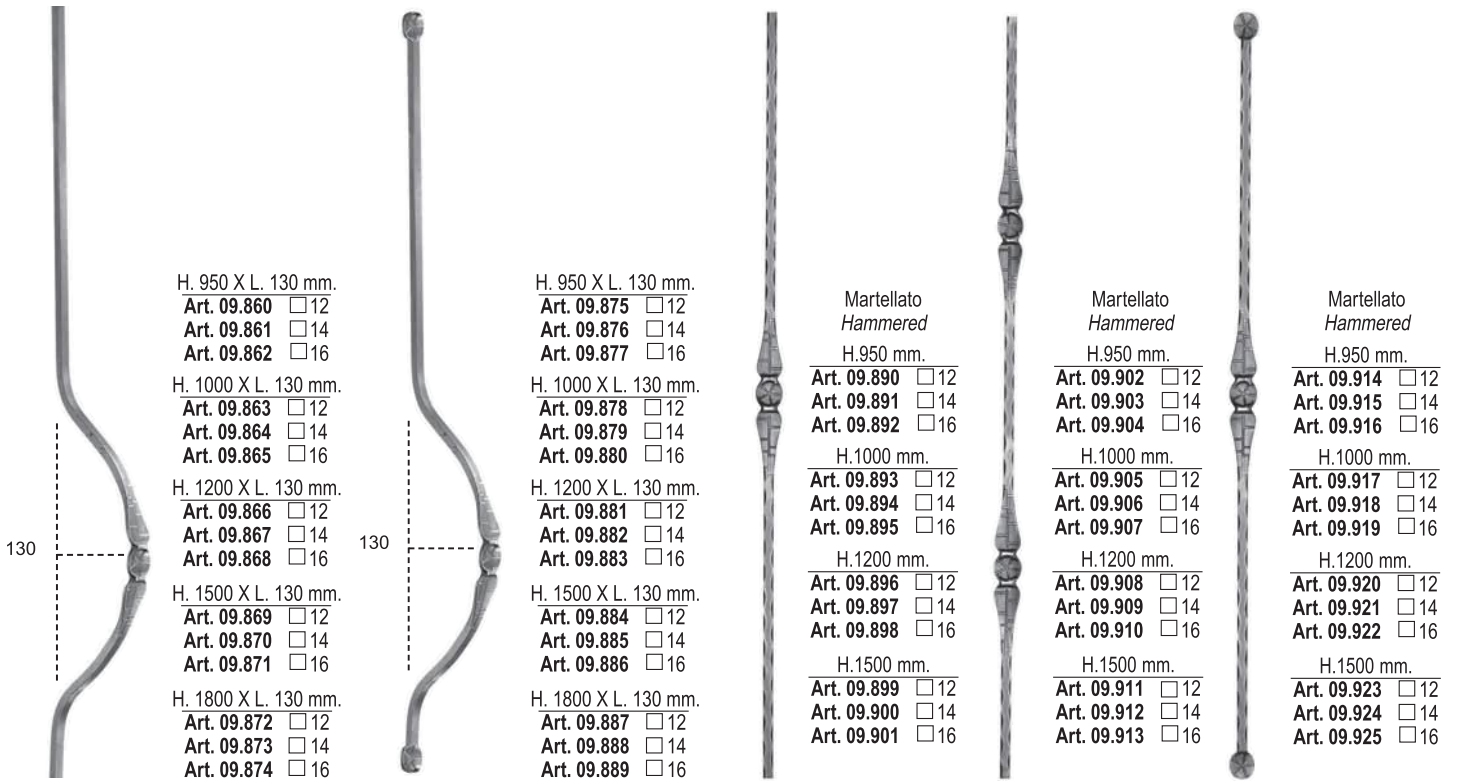

H. 950 X L. 130 mm.
Art. 09.860 12
Art. 09.861 14
Art. 09.862 16

H. 1000 X L. 130 mm.
Art. 09.863 12
Art. 09.864 14
Art. 09.865 16

H. 1200 X L. 130 mm.
Art. 09.866 12
Art. 09.867 14
Art. 09.868 16

H. 1500 X L. 130 mm.
Art. 09.869 12
Art. 09.870 14
Art. 09.871 16

H. 1800 X L. 130 mm.
Art. 09.872 12
Art. 09.873 14
Art. 09.874 16

H. 950 X L. 130 mm.
Art. 09.875 12
Art. 09.876 14
Art. 09.877 16

H. 1000 X L. 130 mm.
Art. 09.878 12
Art. 09.879 14
Art. 09.880 16

H. 1200 X L. 130 mm.
Art. 09.881 12
Art. 09.882 14
Art. 09.883 16

H. 1500 X L. 130 mm.
Art. 09.884 12
Art. 09.885 14
Art. 09.886 16

H. 1800 X L. 130 mm.
Art. 09.887 12
Art. 09.888 14
Art. 09.889 16

Martellato
Hammered

H.950 mm.
Art. 09.890 12
Art. 09.891 14
Art. 09.892 16

H.1000 mm.
Art. 09.893 12
Art. 09.894 14
Art. 09.895 16

H.1200 mm.
Art. 09.896 12
Art. 09.897 14
Art. 09.898 16

H.1500 mm.
Art. 09.899 12
Art. 09.900 14
Art. 09.901 16

Martellato
Hammered

H.950 mm.
Art. 09.902 12
Art. 09.903 14
Art. 09.904 16

H.1000 mm.
Art. 09.905 12
Art. 09.906 14
Art. 09.907 16

H.1200 mm.
Art. 09.908 12
Art. 09.909 14
Art. 09.910 16

H.1500 mm.
Art. 09.911 12
Art. 09.912 14
Art. 09.913 16

Martellato
Hammered

H.950 mm.
Art. 09.914 12
Art. 09.915 14
Art. 09.916 16

H.1000 mm.
Art. 09.917 12
Art. 09.918 14
Art. 09.919 16

H.1200 mm.
Art. 09.920 12
Art. 09.921 14
Art. 09.922 16

H.1500 mm.
Art. 09.923 12
Art. 09.924 14
Art. 09.925 16

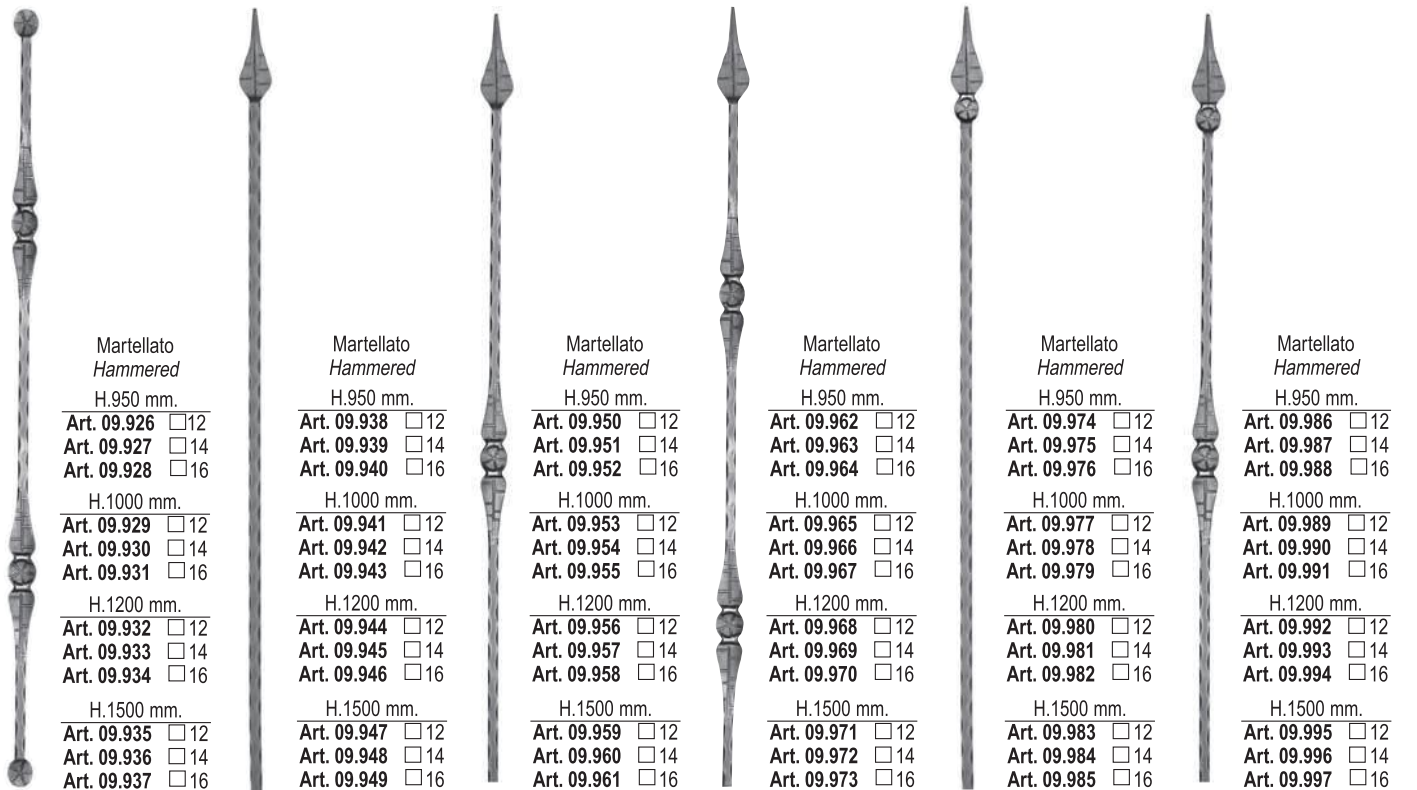

Martellato
Hammered

H.950 mm.
Art. 09.926 12
Art. 09.927 14
Art. 09.928 16

H.1000 mm.
Art. 09.929 12
Art. 09.930 14
Art. 09.931 16

H.1200 mm.
Art. 09.932 12
Art. 09.933 14
Art. 09.934 16

H.1500 mm.
Art. 09.935 12
Art. 09.936 14
Art. 09.937 16

Martellato
Hammered

H.950 mm.
Art. 09.938 12
Art. 09.939 14
Art. 09.940 16

H.1000 mm.
Art. 09.941 12
Art. 09.942 14
Art. 09.943 16

H.1200 mm.
Art. 09.944 12
Art. 09.945 14
Art. 09.946 16

H.1500 mm.
Art. 09.947 12
Art. 09.948 14
Art. 09.949 16

Martellato
Hammered

H.950 mm.
Art. 09.950 12
Art. 09.951 14
Art. 09.952 16

H.1000 mm.
Art. 09.953 12
Art. 09.954 14
Art. 09.955 16

H.1200 mm.
Art. 09.956 12
Art. 09.957 14
Art. 09.958 16

H.1500 mm.
Art. 09.959 12
Art. 09.960 14
Art. 09.961 16

Martellato
Hammered

H.950 mm.
Art. 09.962 12
Art. 09.963 14
Art. 09.964 16

H.1000 mm.
Art. 09.965 12
Art. 09.966 14
Art. 09.967 16

H.1200 mm.
Art. 09.968 12
Art. 09.969 14
Art. 09.970 16

H.1500 mm.
Art. 09.971 12
Art. 09.972 14
Art. 09.973 16

Martellato
Hammered

H.950 mm.
Art. 09.974 12
Art. 09.975 14
Art. 09.976 16

H.1000 mm.
Art. 09.977 12
Art. 09.978 14
Art. 09.979 16

H.1200 mm.
Art. 09.980 12
Art. 09.981 14
Art. 09.982 16

H.1500 mm.
Art. 09.983 12
Art. 09.984 14
Art. 09.985 16

Martellato
Hammered

H.950 mm.
Art. 09.986 12
Art. 09.987 14
Art. 09.988 16

H.1000 mm.
Art. 09.989 12
Art. 09.990 14
Art. 09.991 16

H.1200 mm.
Art. 09.992 12
Art. 09.993 14
Art. 09.994 16

H.1500 mm.
Art. 09.995 12
Art. 09.996 14
Art. 09.997 16



Martellato
Hammered

H.950 mm.
Art. 09.998 12
Art. 09.999 14
Art. 09.999.01 16

H.1000 mm.
Art. 09.999.02 12
Art. 09.999.03 14
Art. 09.999.04 16

H.1200 mm.
Art. 09.999.05 12
Art. 09.999.06 14
Art. 09.999.07 16

H.1500 mm.
Art. 09.999.08 12
Art. 09.999.09 14
Art. 09.999.10 16



Martellato
Hammered

H.950 mm.
Art. 09.999.11 12
Art. 09.999.12 14
Art. 09.999.13 16

H.1000 mm.
Art. 09.999.14 12
Art. 09.999.15 14
Art. 09.999.16 16

H.1200 mm.
Art. 09.999.17 12
Art. 09.999.18 14
Art. 09.999.19 16

H.1500 mm.
Art. 09.999.20 12
Art. 09.999.21 14
Art. 09.999.22 16

H.1800 mm.
Art. 09.999.23 12
Art. 09.999.24 14
Art. 09.999.25 16



Martellato
Hammered

H.950 mm.
Art. 09.999.26 12
Art. 09.999.27 14
Art. 09.999.28 16

H.1000 mm.
Art. 09.999.29 12
Art. 09.999.30 14
Art. 09.999.31 16

H.1200 mm.
Art. 09.999.32 12
Art. 09.999.33 14
Art. 09.999.34 16

H.1500 mm.
Art. 09.999.35 12
Art. 09.999.36 14
Art. 09.999.37 16

H.1800 mm.
Art. 09.999.38 12
Art. 09.999.39 14
Art. 09.999.40 16



Martellato/Hammered

H.950 mm.
Art. 09.1002.01 12
Art. 09.1002.02 14
Art. 09.1002.03 16

H.1000 mm.
Art. 09.1002.04 12
Art. 09.1002.05 14
Art. 09.1002.06 16

H.1200 mm.
Art. 09.1002.07 12
Art. 09.1002.08 14
Art. 09.1002.09 16

H.1500 mm.
Art. 09.1002.10 12
Art. 09.1002.11 14
Art. 09.1002.12 16



Liscio / Smooth

H.950 mm.
Art. 09.1003 14
Art. 09.1003.01 16

H.1000 mm.
Art. 09.1003.02 14
Art. 09.1003.03 16

H.1200 mm.
Art. 09.1003.04 14
Art. 09.1003.05 16

H.1500 mm.
Art. 09.1003.06 14
Art. 09.1003.07 16



Liscio / Smooth

H.950 mm.
Art. 09.1004 12
Art. 09.1004.01 14
Art. 09.1004.02 16

H.1000 mm.
Art. 09.1004.03 12
Art. 09.1004.04 14
Art. 09.1004.05 16

H.1200 mm.
Art. 09.1004.06 12
Art. 09.1004.07 14
Art. 09.1004.08 16

H.1500 mm.
Art. 09.1004.09 12
Art. 09.1004.10 14
Art. 09.1004.11 16



Liscio / Smooth

H.950 mm.
Art. 09.1005 12
Art. 09.1005.01 14
Art. 09.1005.02 16

H.1000 mm.
Art. 09.1005.03 12
Art. 09.1005.04 14
Art. 09.1005.05 16

H.1200 mm.
Art. 09.1005.06 12
Art. 09.1005.07 14
Art. 09.1005.08 16

H.1500 mm.
Art. 09.1005.09 12
Art. 09.1005.10 14
Art. 09.1005.11 16



Martellato/Hammered

H.950 mm.
Art. 09.1006 12
Art. 09.1006.01 14
Art. 09.1006.02 16

H.1000 mm.
Art. 09.1006.03 12
Art. 09.1006.04 14
Art. 09.1006.05 16

H.1200 mm.
Art. 09.1006.06 12
Art. 09.1006.07 14
Art. 09.1006.08 16

H.1500 mm.
Art. 09.1006.09 12
Art. 09.1006.10 14
Art. 09.1006.11 16





Liscio / Smooth
H.950 mm.
Art. 09.1007 Ø 12
Art. 09.1007.01 Ø 14

H.1000 mm.
Art. 09.1007.02 Ø 12
Art. 09.1007.03 Ø 14

H.1200 mm.
Art. 09.1007.04 Ø 12
Art. 09.1007.05 Ø 14

H.1500 mm.
Art. 09.1007.06 Ø 12
Art. 09.1007.07 Ø 14



Liscio / Smooth
H.950 mm.
Art. 09.1008 □ 12



Liscio / Smooth
H.950 mm.
Art. 09.1009 □ 12



Martellato / Hammered
H.950 mm.
Art. 09.1010 □ 12



Martellato / Hammered
H.950 mm.
Art. 09.1011 □ 12



Fuori Produzione
Out Of Production

Liscio / Smooth
H.950 mm.
Art. 09.1012 □ 12

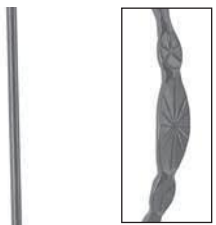

100
o / or
150

Liscio / Smooth
H.950 X L.100 mm.
Art. 09.1013 Ø 12
Art. 09.1013.01 Ø 14
H.950 X L.150 mm.
Art. 09.1013.02 Ø 12
Art. 09.1013.03 Ø 14

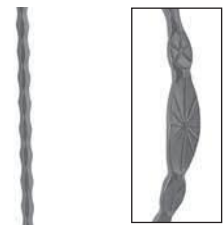

100
o / or
150

Martellato / Hammered
H.950 X L.100 mm.
Art. 09.1014 □ 14
H.950 X L.150 mm.
Art. 09.1014.01 □ 14



100
o / or
150

Liscio / Smooth
H.950 X L.100 mm.
Art. 09.1015 □ 14
H.950 X L.150 mm.
Art. 09.1015.01 □ 14



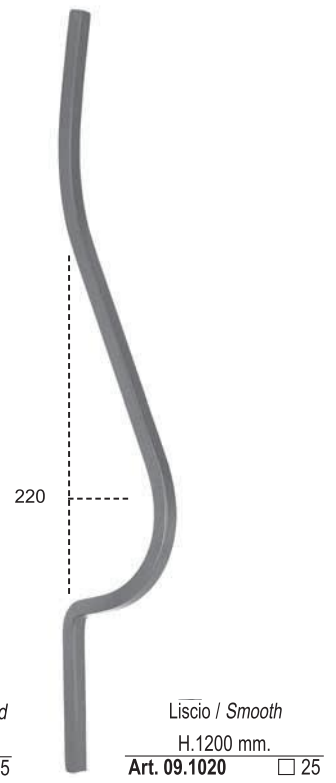
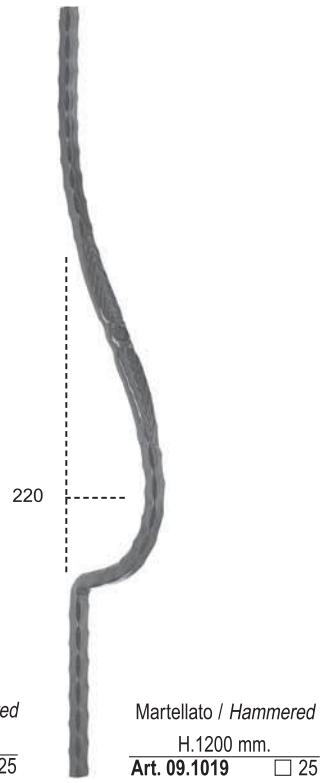
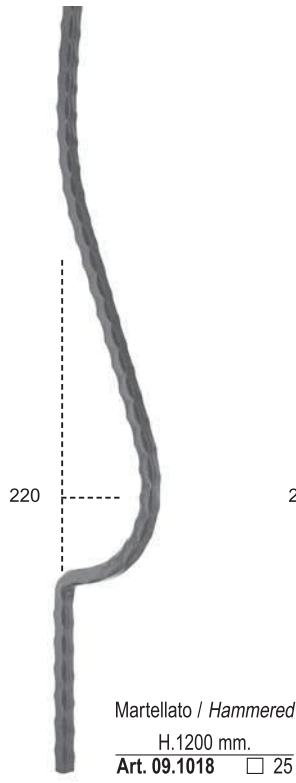
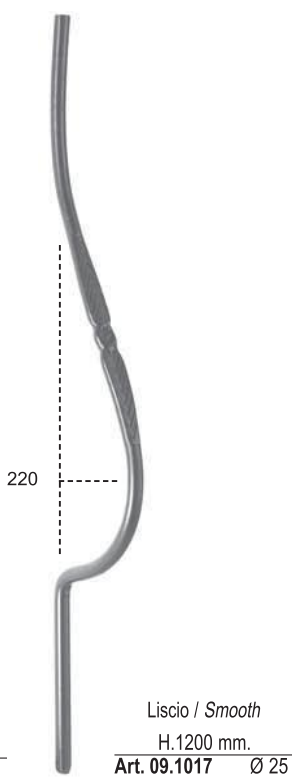
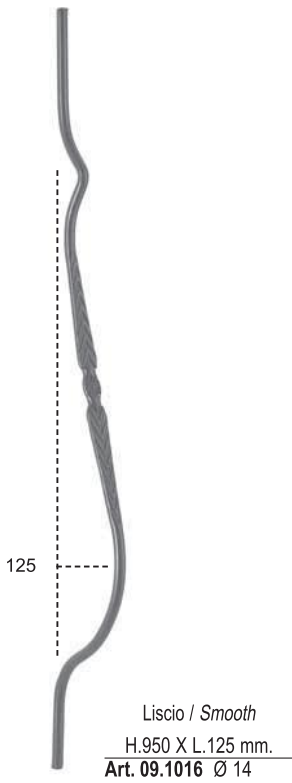

Art. 09.1022 □ 14 mm
Art. 09.1023 □ 16 mm

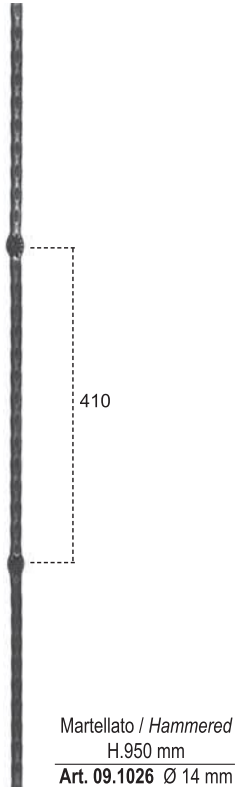
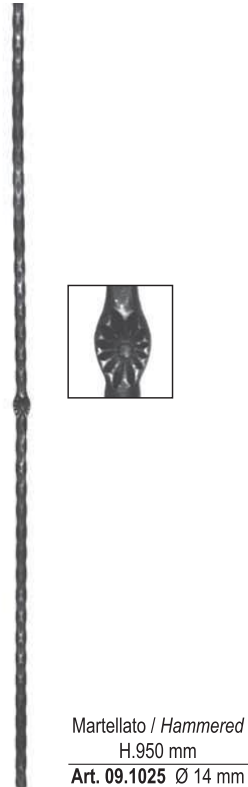



Schiacciata sullo spigolo /
Ornament on the edge
Liscio / Smooth

H 950 mm

Art. 09.1050 □ 12x12 mm
Art. 09.1051 □ 14x14 mm
Art. 09.1052 □ 16x16 mm

H 1000 mm

Art. 09.1053 □ 12x12 mm
Art. 09.1054 □ 14x14 mm
Art. 09.1055 □ 16x16 mm

H 1200 mm

Art. 09.1056 □ 12x12 mm
Art. 09.1057 □ 14x14 mm
Art. 09.1058 □ 16x16 mm



Schiacciata sullo spigolo /
Ornament on the edge
Liscio / Smooth

H 950 mm

Art. 09.1059 □ 12x12 mm
Art. 09.1060 □ 14x14 mm
Art. 09.1061 □ 16x16 mm

H 1000 mm

Art. 09.1062 □ 12x12 mm
Art. 09.1063 □ 14x14 mm
Art. 09.1064 □ 16x16 mm

H 1200 mm

Art. 09.1065 □ 12x12 mm
Art. 09.1066 □ 14x14 mm
Art. 09.1067 □ 16x16 mm



Schiacciata sullo spigolo /
Ornament on the edge
Martellato / Hammered

H 950 mm

Art. 09.1068 □ 12x12 mm
Art. 09.1069 □ 14x14 mm
Art. 09.1070 □ 16x16 mm

H 1000 mm

Art. 09.1071 □ 12x12 mm
Art. 09.1072 □ 14x14 mm
Art. 09.1073 □ 16x16 mm

H 1200 mm

Art. 09.1074 □ 12x12 mm
Art. 09.1075 □ 14x14 mm
Art. 09.1076 □ 16x16 mm



Schiacciata sullo spigolo /
Ornament on the edge
Martellato / Hammered

H 950 mm

Art. 09.1077 □ 12x12 mm
Art. 09.1078 □ 14x14 mm
Art. 09.1079 □ 16x16 mm

H 1000 mm

Art. 09.1080 □ 12x12 mm
Art. 09.1081 □ 14x14 mm
Art. 09.1082 □ 16x16 mm

H 1200 mm

Art. 09.1083 □ 12x12 mm
Art. 09.1084 □ 14x14 mm
Art. 09.1085 □ 16x16 mm



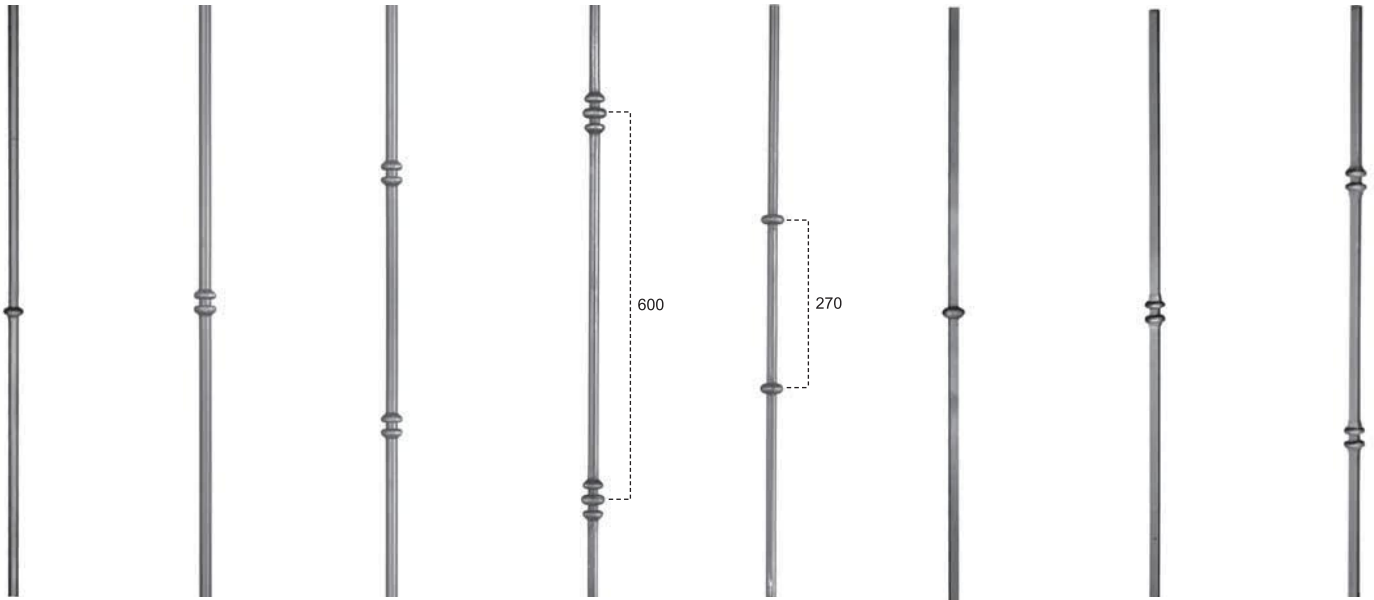

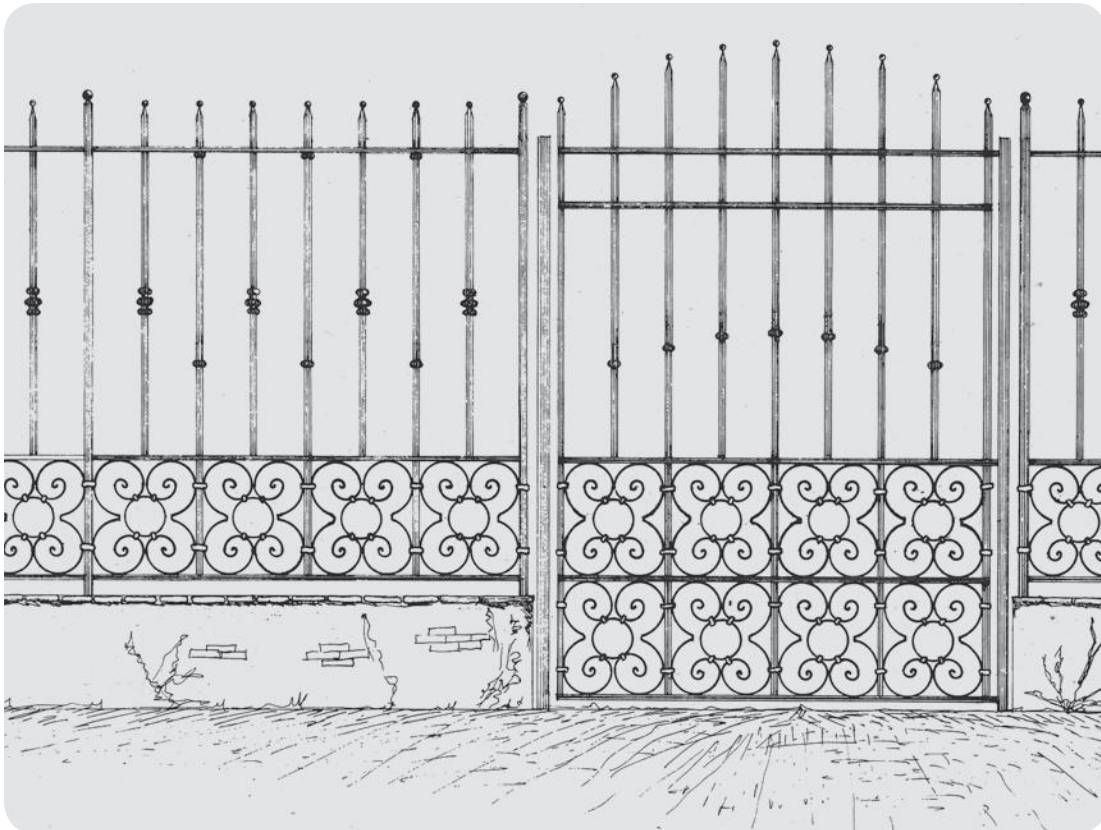

Tondo / Round		Tondo / Round		Tondo / Round		Tondo / Round		Tondo / Round		Tondo / Round		Tondo / Round		Tondo / Round	
H.950 mm.		H.950 mm.		H.950 mm.		H.1500 mm.		H.950 mm.		H.950 mm.		H.950 mm.		H.950 mm.	
Art. 10.001	Ø 16	Art. 10.005	Ø 16	Art. 10.009	Ø 16	Art. 10.012.03	Ø 12	Art. 10.012.09	Ø 12	Art. 10.013	□ 14	Art. 10.017	□ 14	Art. 10.021	□ 14
Art. 10.001.01	Ø 14	Art. 10.005.01	Ø 14	Art. 10.009.01	Ø 14	Art. 10.012.04	Ø 14	Art. 10.012.10	Ø 14	Art. 10.013.01	□ 16	Art. 10.017.01	□ 16	Art. 10.021.01	□ 16
Art. 10.001.02	Ø 12	Art. 10.005.02	Ø 12	Art. 10.009.02	Ø 12	Art. 10.012.05	Ø 16	Art. 10.012.11	Ø 16	Art. 10.013.02	□ 12	Art. 10.017.02	□ 12	Art. 10.021.02	□ 12
H.1000 mm.		H.1000 mm.		H.1000 mm.		H.1800 mm.		H.950 mm.		H.1000 mm.		H.1000 mm.		H.1000 mm.	
Art. 10.002	Ø 16	Art. 10.006	Ø 16	Art. 10.010	Ø 16	Art. 10.012.06	Ø 12	Art. 10.014	□ 14	Art. 10.014	□ 14	Art. 10.018	□ 14	Art. 10.022	□ 14
Art. 10.002.01	Ø 14	Art. 10.006.01	Ø 14	Art. 10.010.01	Ø 14	Art. 10.012.07	Ø 14	Art. 10.014.01	□ 16	Art. 10.014.01	□ 16	Art. 10.018.01	□ 16	Art. 10.022.01	□ 16
Art. 10.002.02	Ø 12	Art. 10.006.02	Ø 12	Art. 10.010.02	Ø 12	Art. 10.012.08	Ø 16	Art. 10.014.02	□ 12	Art. 10.014.02	□ 12	Art. 10.018.02	□ 12	Art. 10.022.02	□ 12
H.1200 mm.		H.1200 mm.		H.1200 mm.				H.1200 mm.		H.1200 mm.		H.1200 mm.		H.1200 mm.	
Art. 10.003	Ø 16	Art. 10.007	Ø 16	Art. 10.011	Ø 16			Art. 10.015	□ 14	Art. 10.015	□ 14	Art. 10.019	□ 14	Art. 10.023	□ 14
Art. 10.003.01	Ø 14	Art. 10.007.01	Ø 14	Art. 10.011.01	Ø 14			Art. 10.015.01	□ 16	Art. 10.015.01	□ 16	Art. 10.019.01	□ 16	Art. 10.023.01	□ 16
Art. 10.003.02	Ø 12	Art. 10.007.02	Ø 12	Art. 10.011.02	Ø 12			Art. 10.015.02	□ 12	Art. 10.015.02	□ 12	Art. 10.019.02	□ 12	Art. 10.023.02	□ 12
H.1500 mm.		H.1500 mm.		H.1500 mm.				H.1500 mm.		H.1500 mm.		H.1500 mm.		H.1500 mm.	
Art. 10.004	Ø 16	Art. 10.008	Ø 16	Art. 10.012	Ø 16			Art. 10.016	□ 14	Art. 10.020	□ 14	Art. 10.020	□ 14	Art. 10.024	□ 14
Art. 10.004.01	Ø 14	Art. 10.008.01	Ø 14	Art. 10.012.01	Ø 14			Art. 10.016.01	□ 16	Art. 10.020.01	□ 16	Art. 10.020.01	□ 16	Art. 10.024.01	□ 16
Art. 10.004.02	Ø 12	Art. 10.008.02	Ø 12	Art. 10.012.02	Ø 12			Art. 10.016.02	□ 12	Art. 10.020.02	□ 12	Art. 10.020.02	□ 12	Art. 10.024.02	□ 12



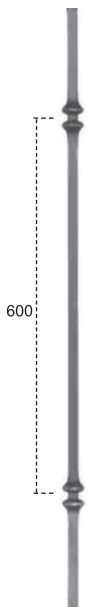

H.1800 mm.	
Art. 10.020.03	□ 14
Art. 10.020.04	□ 16
H.2000 mm.	
Art. 10.020.05	□ 14
Art. 10.020.06	□ 16





H.1500 mm.	
Art. 10.024.03	□ 14
Art. 10.024.04	□ 16
H.1800 mm.	
Art. 10.024.05	□ 14
Art. 10.024.06	□ 16
H.2000 mm.	
Art. 10.024.07	□ 14
Art. 10.024.08	□ 16

	
H.950 mm.	
Art. 10.025	<input type="checkbox"/> 14
Art. 10.025.01	<input type="checkbox"/> 16
Art. 10.025.02	<input type="checkbox"/> 12
Art. 10.026	Ø 16
Art. 10.026.01	Ø 14
Art. 10.026.02	Ø 12
H.1000 mm.	
Art. 10.027	<input type="checkbox"/> 14
Art. 10.027.01	<input type="checkbox"/> 16
Art. 10.027.02	<input type="checkbox"/> 12
Art. 10.028	Ø 16
Art. 10.028.01	Ø 14
Art. 10.028.02	Ø 12
H.1200 mm.	
Art. 10.029	<input type="checkbox"/> 14
Art. 10.029.01	<input type="checkbox"/> 16
Art. 10.029.02	<input type="checkbox"/> 12
Art. 10.030	Ø 16
Art. 10.030.01	Ø 14
Art. 10.030.02	Ø 12
H.1500 mm.	
Art. 10.031	<input type="checkbox"/> 14
Art. 10.031.01	<input type="checkbox"/> 16
Art. 10.031.02	<input type="checkbox"/> 12
Art. 10.032	Ø 16
Art. 10.032.01	Ø 14
Art. 10.032.02	Ø 12
H.2000 mm.	
Art. 10.032.18	Ø 16
H.2500 mm.	
Art. 10.032.20	<input type="checkbox"/> 14
Art. 10.032.21	<input type="checkbox"/> 16

	
H.950 mm.	
Art. 10.033	<input type="checkbox"/> 14
Art. 10.033.01	<input type="checkbox"/> 16
Art. 10.033.02	<input type="checkbox"/> 12
Art. 10.034	Ø 16
Art. 10.034.01	Ø 14
Art. 10.034.02	Ø 12
H.1000 mm.	
Art. 10.035	<input type="checkbox"/> 14
Art. 10.035.01	<input type="checkbox"/> 16
Art. 10.035.02	<input type="checkbox"/> 12
Art. 10.036	Ø 16
Art. 10.036.01	Ø 14
Art. 10.036.02	Ø 12
H.1200 mm.	
Art. 10.037	<input type="checkbox"/> 14
Art. 10.037.01	<input type="checkbox"/> 16
Art. 10.037.02	<input type="checkbox"/> 12
Art. 10.038	Ø 16
Art. 10.038.01	Ø 14
Art. 10.038.02	Ø 12
H.1500 mm.	
Art. 10.039	<input type="checkbox"/> 14
Art. 10.039.01	<input type="checkbox"/> 16
Art. 10.039.02	<input type="checkbox"/> 12
Art. 10.040	Ø 16
Art. 10.040.01	Ø 14
Art. 10.040.02	Ø 12

	
Martellato / Hammered	
H.950 mm.	
Art. 10.040.03	<input type="checkbox"/> 12
Art. 10.040.04	<input type="checkbox"/> 14
Art. 10.040.05	<input type="checkbox"/> 16
H.1000 mm.	
Art. 10.040.06	<input type="checkbox"/> 12
Art. 10.040.07	<input type="checkbox"/> 14
Art. 10.040.08	<input type="checkbox"/> 16
H.1200 mm.	
Art. 10.040.09	<input type="checkbox"/> 12
Art. 10.040.10	<input type="checkbox"/> 14
Art. 10.040.11	<input type="checkbox"/> 16
H.1500 mm.	
Art. 10.040.12	<input type="checkbox"/> 12
Art. 10.040.13	<input type="checkbox"/> 14
Art. 10.040.14	<input type="checkbox"/> 16





	
Martellato / Hammered	
H.950 mm.	
Art. 10.040.15	<input type="checkbox"/> 12
Art. 10.040.16	<input type="checkbox"/> 14
Art. 10.040.17	<input type="checkbox"/> 16
H.1000 mm.	
Art. 10.040.18	<input type="checkbox"/> 12
Art. 10.040.19	<input type="checkbox"/> 14
Art. 10.040.20	<input type="checkbox"/> 16
H.1200 mm.	
Art. 10.040.21	<input type="checkbox"/> 12
Art. 10.040.22	<input type="checkbox"/> 14
Art. 10.040.23	<input type="checkbox"/> 16
H.1500 mm.	
Art. 10.040.24	<input type="checkbox"/> 12
Art. 10.040.25	<input type="checkbox"/> 14
Art. 10.040.26	<input type="checkbox"/> 16

	
Martellato / Hammered	
H.950 mm.	
Art. 10.041	<input type="checkbox"/> 14
Art. 10.041.01	<input type="checkbox"/> 16
Art. 10.041.02	<input type="checkbox"/> 12
H.1000 mm.	
Art. 10.042	<input type="checkbox"/> 14
Art. 10.042.01	<input type="checkbox"/> 16
Art. 10.042.02	<input type="checkbox"/> 12
H.1200 mm.	
Art. 10.043	<input type="checkbox"/> 14
Art. 10.043.01	<input type="checkbox"/> 16
Art. 10.043.02	<input type="checkbox"/> 12
H.1500 mm.	
Art. 10.044	<input type="checkbox"/> 14
Art. 10.044.01	<input type="checkbox"/> 16
Art. 10.044.02	<input type="checkbox"/> 12

	
Martellato / Hammered	
H.950 mm.	
Art. 10.045	<input type="checkbox"/> 14
Art. 10.045.01	<input type="checkbox"/> 16
Art. 10.045.02	<input type="checkbox"/> 12
H.1000 mm.	
Art. 10.046	<input type="checkbox"/> 14
Art. 10.046.01	<input type="checkbox"/> 16
Art. 10.046.02	<input type="checkbox"/> 12
H.1200 mm.	
Art. 10.047	<input type="checkbox"/> 14
Art. 10.047.01	<input type="checkbox"/> 16
Art. 10.047.02	<input type="checkbox"/> 12
H.1500 mm.	
Art. 10.048	<input type="checkbox"/> 14
Art. 10.048.01	<input type="checkbox"/> 16
Art. 10.048.02	<input type="checkbox"/> 12



Paletti ricalcati - Tendenze Odierne / New forged bars - Modern Design

			
Martellato / Hammered		Martellato / Hammered	
H.950 mm.		H.950 mm.	
Art. 09.658	<input type="checkbox"/> 12	Art. 09.662	<input type="checkbox"/> 12
Art. 09.659	<input type="checkbox"/> 14	Art. 09.663	<input type="checkbox"/> 14
		Art. 09.664	<input type="checkbox"/> 12
		Art. 09.665	<input type="checkbox"/> 14

Tutte le parti di questo catalogo - foto comprese - sono di proprietà Euro-Fer. La riproduzione, anche parziale, è vietata in ogni forma e con ogni mezzo. / Every part of this catalogue - photos included - is Euro-Fer's property. All forms of copying are strictly prohibited.

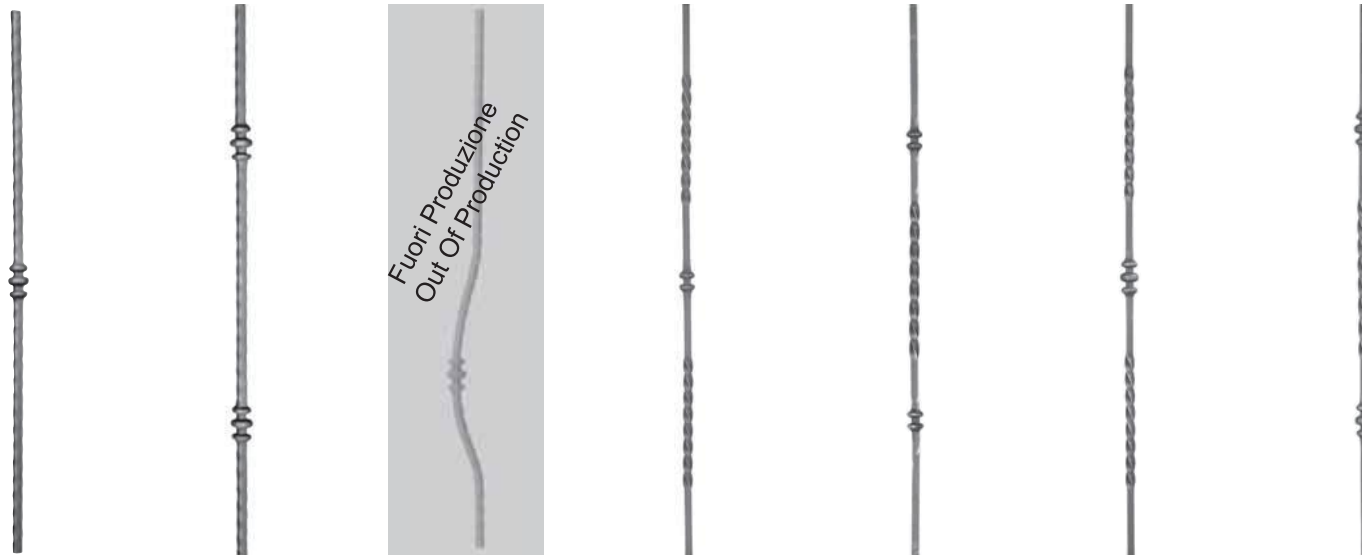

Martellato/Hammered

Martellato/Hammered

H.950 mm.
Art. 10.049 14
Art. 10.049.01 16
Art. 10.049.02 12

H.950 mm.
Art. 10.053 14
Art. 10.053.01 16
Art. 10.053.02 12

H.1000 mm.
Art. 10.050 14
Art. 10.050.01 16
Art. 10.050.02 12

H.1000 mm.
Art. 10.054 14
Art. 10.054.01 16
Art. 10.054.02 12

H.1200 mm.
Art. 10.051 14
Art. 10.051.01 16
Art. 10.051.02 12

H.1200 mm.
Art. 10.055 14
Art. 10.055.01 16
Art. 10.055.02 12

H.1500 mm.
Art. 10.052 14
Art. 10.052.01 16
Art. 10.052.02 12

H.1500 mm.
Art. 10.056 14
Art. 10.056.01 16
Art. 10.056.02 12

H.1800 mm.
Art. 10.052.03 12
Art. 10.052.04 14
Art. 10.052.05 16

H.2000 mm.
Art. 10.052.06 12
Art. 10.052.07 14
Art. 10.052.08 16

H.950 mm.
Art. 10.056.03 12
Art. 10.056.04 14
Art. 10.056.05 16

H.1000 mm.
Art. 10.056.06 12
Art. 10.056.07 14
Art. 10.056.08 16

H.1200 mm.
Art. 10.056.09 12
Art. 10.056.10 14
Art. 10.056.11 16

H.1500 mm.
Art. 10.056.12 12
Art. 10.056.13 14
Art. 10.056.14 16

H.950 mm.
Art. 10.056.15 12
Art. 10.056.16 14
Art. 10.056.17 16

H.1000 mm.
Art. 10.056.18 12
Art. 10.056.19 14
Art. 10.056.20 16

H.1200 mm.
Art. 10.056.21 12
Art. 10.056.22 14
Art. 10.056.23 16

H.1500 mm.
Art. 10.056.24 12
Art. 10.056.25 14
Art. 10.056.26 16

H.950 mm.
Art. 10.056.27 12
Art. 10.056.28 14
Art. 10.056.29 16

H.1000 mm.
Art. 10.056.30 12
Art. 10.056.31 14
Art. 10.056.32 16

H.1200 mm.
Art. 10.056.33 12
Art. 10.056.34 14
Art. 10.056.35 16

H.1500 mm.
Art. 10.056.36 12
Art. 10.056.37 14
Art. 10.056.38 16

H.950 mm.
Art. 10.056.39 12
Art. 10.056.40 14
Art. 10.056.41 16

H.1000 mm.
Art. 10.056.42 12
Art. 10.056.43 14
Art. 10.056.44 16

H.1200 mm.
Art. 10.056.45 12
Art. 10.056.46 14
Art. 10.056.47 16

H.1500 mm.
Art. 10.056.48 12
Art. 10.056.49 14
Art. 10.056.50 16

H.950 mm.
Art. 10.056.51 12
Art. 10.056.52 14
Art. 10.056.53 16

H.1000 mm.
Art. 10.056.54 12
Art. 10.056.55 14
Art. 10.056.56 16

H.1200 mm.
Art. 10.056.57 12
Art. 10.056.58 14
Art. 10.056.59 16

H.1500 mm.
Art. 10.056.60 12
Art. 10.056.61 14
Art. 10.056.62 16

PALLINE GRANDI / LARGE BALLS

	H.950 mm. Art. 10.057 <input type="checkbox"/> 14 Art. 10.057.01 <input type="checkbox"/> 16 Art. 10.057.02 <input type="checkbox"/> 12		H.950 mm. Art. 10.061 <input type="checkbox"/> 14 Art. 10.061.01 <input type="checkbox"/> 16 Art. 10.061.02 <input type="checkbox"/> 12 Art. 10.062 <input type="checkbox"/> 16 Art. 10.062.01 <input type="checkbox"/> 14 Art. 10.062.02 <input type="checkbox"/> 12		H.950 mm. Art. 10.068.60 <input type="checkbox"/> 14 Art. 10.068.61 <input type="checkbox"/> 12		H.950 mm. Art. 10.069 <input type="checkbox"/> 14 Art. 10.069.01 <input type="checkbox"/> 16 Art. 10.069.02 <input type="checkbox"/> 12 Art. 10.070 <input type="checkbox"/> 16 Art. 10.070.01 <input type="checkbox"/> 14 Art. 10.070.02 <input type="checkbox"/> 12		H.950 mm. Art. 10.077 <input type="checkbox"/> 14 Art. 10.077.01 <input type="checkbox"/> 16 Art. 10.077.02 <input type="checkbox"/> 12 Art. 10.078 <input type="checkbox"/> 16 Art. 10.078.01 <input type="checkbox"/> 14 Art. 10.078.02 <input type="checkbox"/> 12
	H.1000 mm. Art. 10.058 <input type="checkbox"/> 14 Art. 10.058.01 <input type="checkbox"/> 16 Art. 10.058.02 <input type="checkbox"/> 12		H.1000 mm. Art. 10.063 <input type="checkbox"/> 14 Art. 10.063.01 <input type="checkbox"/> 16 Art. 10.063.02 <input type="checkbox"/> 12 Art. 10.064 <input type="checkbox"/> 16 Art. 10.064.01 <input type="checkbox"/> 14 Art. 10.064.02 <input type="checkbox"/> 12		H.1000 mm. Art. 10.068.62 <input type="checkbox"/> 14 Art. 10.068.63 <input type="checkbox"/> 12		H.1000 mm. Art. 10.071 <input type="checkbox"/> 14 Art. 10.071.01 <input type="checkbox"/> 16 Art. 10.071.02 <input type="checkbox"/> 12 Art. 10.072 <input type="checkbox"/> 16 Art. 10.072.01 <input type="checkbox"/> 14 Art. 10.072.02 <input type="checkbox"/> 12		H.1000 mm. Art. 10.079 <input type="checkbox"/> 14 Art. 10.079.01 <input type="checkbox"/> 16 Art. 10.079.02 <input type="checkbox"/> 12 Art. 10.080 <input type="checkbox"/> 16 Art. 10.080.01 <input type="checkbox"/> 14 Art. 10.080.02 <input type="checkbox"/> 12
	H.1200 mm. Art. 10.059 <input type="checkbox"/> 14 Art. 10.059.01 <input type="checkbox"/> 16 Art. 10.059.02 <input type="checkbox"/> 12		H.1200 mm. Art. 10.065 <input type="checkbox"/> 14 Art. 10.065.01 <input type="checkbox"/> 16 Art. 10.065.02 <input type="checkbox"/> 12 Art. 10.066 <input type="checkbox"/> 16 Art. 10.066.01 <input type="checkbox"/> 14 Art. 10.066.02 <input type="checkbox"/> 12		H.1200 mm. Art. 10.068.64 <input type="checkbox"/> 14 Art. 10.068.65 <input type="checkbox"/> 12		H.1200 mm. Art. 10.073 <input type="checkbox"/> 14 Art. 10.073.01 <input type="checkbox"/> 16 Art. 10.073.02 <input type="checkbox"/> 12 Art. 10.074 <input type="checkbox"/> 16 Art. 10.074.01 <input type="checkbox"/> 14 Art. 10.074.02 <input type="checkbox"/> 12		H.1200 mm. Art. 10.081 <input type="checkbox"/> 14 Art. 10.081.01 <input type="checkbox"/> 16 Art. 10.081.02 <input type="checkbox"/> 12 Art. 10.082 <input type="checkbox"/> 16 Art. 10.082.01 <input type="checkbox"/> 14 Art. 10.082.02 <input type="checkbox"/> 12
	H.1400 mm. Art. 10.059.10 <input type="checkbox"/> 14 NEW		H.1200 mm. Art. 10.067 <input type="checkbox"/> 14 Art. 10.067.01 <input type="checkbox"/> 16 Art. 10.067.02 <input type="checkbox"/> 12 Art. 10.068 <input type="checkbox"/> 16 Art. 10.068.01 <input type="checkbox"/> 14 Art. 10.068.02 <input type="checkbox"/> 12		H.1500 mm. Art. 10.068.66 <input type="checkbox"/> 14 Art. 10.068.67 <input type="checkbox"/> 12		H.1200 mm. Art. 10.075 <input type="checkbox"/> 14 Art. 10.075.01 <input type="checkbox"/> 16 Art. 10.075.02 <input type="checkbox"/> 12 Art. 10.076 <input type="checkbox"/> 16 Art. 10.076.01 <input type="checkbox"/> 14 Art. 10.076.02 <input type="checkbox"/> 12		H.1200 mm. Art. 10.083 <input type="checkbox"/> 14 Art. 10.083.01 <input type="checkbox"/> 16 Art. 10.083.02 <input type="checkbox"/> 12 Art. 10.084 <input type="checkbox"/> 16 Art. 10.084.01 <input type="checkbox"/> 14 Art. 10.084.02 <input type="checkbox"/> 12
	H.1500 mm. Art. 10.060 <input type="checkbox"/> 14 Art. 10.060.01 <input type="checkbox"/> 16 Art. 10.060.02 <input type="checkbox"/> 12		H.1500 mm. Art. 10.069 <input type="checkbox"/> 14 Art. 10.069.01 <input type="checkbox"/> 16 Art. 10.069.02 <input type="checkbox"/> 12 Art. 10.070 <input type="checkbox"/> 16 Art. 10.070.01 <input type="checkbox"/> 14 Art. 10.070.02 <input type="checkbox"/> 12				H.1500 mm. Art. 10.077 <input type="checkbox"/> 14 Art. 10.077.01 <input type="checkbox"/> 16 Art. 10.077.02 <input type="checkbox"/> 12 Art. 10.078 <input type="checkbox"/> 16 Art. 10.078.01 <input type="checkbox"/> 14 Art. 10.078.02 <input type="checkbox"/> 12		H.1500 mm. Art. 10.085 <input type="checkbox"/> 14 Art. 10.085.01 <input type="checkbox"/> 16 Art. 10.085.02 <input type="checkbox"/> 12 Art. 10.086 <input type="checkbox"/> 16 Art. 10.086.01 <input type="checkbox"/> 14 Art. 10.086.02 <input type="checkbox"/> 12
	H.1700 mm. Art. 10.060.10 <input type="checkbox"/> 14 NEW								

ELEMENTI IN FERRO RICALCATO NEW FORGED BARS

10

PALLINE GRANDI / LARGE BALLS

NEW



H.950 mm.

- Art. 10.085 □ 14
- Art. 10.085.01 □ 16
- Art. 10.085.02 □ 12
- Art. 10.086 Ø 16
- Art. 10.086.01 Ø 14
- Art. 10.086.02 Ø 12



H.950 mm.

- Art. 10.093 □ 14
- Art. 10.093.01 □ 16
- Art. 10.093.02 □ 12
- Art. 10.094 Ø 16
- Art. 10.094.01 Ø 14
- Art. 10.094.02 Ø 12



H.950 mm.

- Art. 10.101 □ 14
- Art. 10.101.01 □ 16
- Art. 10.101.02 □ 12
- Art. 10.102 Ø 16
- Art. 10.102.01 Ø 14
- Art. 10.102.02 Ø 12



H.950 mm.

- Art. 10.108.60 □ 14
- Art. 10.108.61 □ 16
- Art. 10.108.62 □ 12
- Art. 10.108.63 Ø 16
- Art. 10.108.64 Ø 14
- Art. 10.108.65 Ø 12



H.1000 mm.

- Art. 10.108.106 □ 14
- Art. 10.108.108 □ 12



H.950 mm.

- Art. 10.109 □ 14
- Art. 10.109.01 □ 16
- Art. 10.109.02 □ 12
- Art. 10.110 Ø 16
- Art. 10.110.01 Ø 14
- Art. 10.110.02 Ø 12



H.950 mm.

- Art. 10.117 □ 14
- Art. 10.117.01 □ 16
- Art. 10.117.02 □ 12
- Art. 10.118 Ø 16
- Art. 10.118.01 Ø 14
- Art. 10.118.02 Ø 12

H.1000 mm.

- Art. 10.087 □ 14
- Art. 10.087.01 □ 16
- Art. 10.087.02 □ 12
- Art. 10.088 Ø 16
- Art. 10.088.01 Ø 14
- Art. 10.088.02 Ø 12

H.1000 mm.

- Art. 10.095 □ 14
- Art. 10.095.01 □ 16
- Art. 10.095.02 □ 12
- Art. 10.096 Ø 16
- Art. 10.096.01 Ø 14
- Art. 10.096.02 Ø 12

H.1000 mm.

- Art. 10.103 □ 14
- Art. 10.103.01 □ 16
- Art. 10.103.02 □ 12
- Art. 10.104 Ø 16
- Art. 10.104.01 Ø 14
- Art. 10.104.02 Ø 12

H.1000 mm.

- Art. 10.108.66 □ 14
- Art. 10.108.67 □ 16
- Art. 10.108.68 □ 12
- Art. 10.108.69 Ø 16
- Art. 10.108.70 Ø 14
- Art. 10.108.71 Ø 12

H.1000 mm.

- Art. 10.111 □ 14
- Art. 10.111.01 □ 16
- Art. 10.111.02 □ 12
- Art. 10.112 Ø 16
- Art. 10.112.01 Ø 14
- Art. 10.112.02 Ø 12

H.1000 mm.

- Art. 10.119 □ 14
- Art. 10.119.01 □ 16
- Art. 10.119.02 □ 12
- Art. 10.120 Ø 16
- Art. 10.120.01 Ø 14
- Art. 10.120.02 Ø 12

H.1200 mm.

- Art. 10.089 □ 14
- Art. 10.089.01 □ 16
- Art. 10.089.02 □ 12
- Art. 10.090 Ø 16
- Art. 10.090.01 Ø 14
- Art. 10.090.02 Ø 12

H.1200 mm.

- Art. 10.097 □ 14
- Art. 10.097.01 □ 16
- Art. 10.097.02 □ 12
- Art. 10.098 Ø 16
- Art. 10.098.01 Ø 14
- Art. 10.098.02 Ø 12

H.1200 mm.

- Art. 10.105 □ 14
- Art. 10.105.01 □ 16
- Art. 10.105.02 □ 12
- Art. 10.106 Ø 16
- Art. 10.106.01 Ø 14
- Art. 10.106.02 Ø 12

H.1200 mm.

- Art. 10.108.72 □ 14
- Art. 10.108.73 □ 16
- Art. 10.108.74 □ 12
- Art. 10.108.75 Ø 16
- Art. 10.108.76 Ø 14
- Art. 10.108.77 Ø 12

H.1200 mm.

- Art. 10.113 □ 14
- Art. 10.113.01 □ 16
- Art. 10.113.02 □ 12
- Art. 10.114 Ø 16
- Art. 10.114.01 Ø 14
- Art. 10.114.02 Ø 12

H.1200 mm.

- Art. 10.121 □ 14
- Art. 10.121.01 □ 16
- Art. 10.121.02 □ 12
- Art. 10.122 Ø 16
- Art. 10.122.01 Ø 14
- Art. 10.122.02 Ø 12

H.1500 mm.

- Art. 10.091 □ 14
- Art. 10.091.01 □ 16
- Art. 10.091.02 □ 12
- Art. 10.092 Ø 16
- Art. 10.092.01 Ø 14
- Art. 10.092.02 Ø 12

H.1500 mm.

- Art. 10.099 □ 14
- Art. 10.099.01 □ 16
- Art. 10.099.02 □ 12
- Art. 10.100 Ø 16
- Art. 10.100.01 Ø 14
- Art. 10.100.02 Ø 12

H.1500 mm.

- Art. 10.107 □ 14
- Art. 10.107.01 □ 16
- Art. 10.107.02 □ 12
- Art. 10.108 Ø 16
- Art. 10.108.01 Ø 14
- Art. 10.108.02 Ø 12

H.1500 mm.

- Art. 10.108.78 □ 14
- Art. 10.108.79 □ 16
- Art. 10.108.80 □ 12
- Art. 10.108.81 Ø 16
- Art. 10.108.82 Ø 14
- Art. 10.108.83 Ø 12

H.1500 mm.

- Art. 10.115 □ 14
- Art. 10.115.01 □ 16
- Art. 10.115.02 □ 12
- Art. 10.116 Ø 16
- Art. 10.116.01 Ø 14
- Art. 10.116.02 Ø 12

H.1500 mm.

- Art. 10.123 □ 14
- Art. 10.123.01 □ 16
- Art. 10.123.02 □ 12
- Art. 10.124 Ø 16
- Art. 10.124.01 Ø 14
- Art. 10.124.02 Ø 12

H.950 mm.

- Art. 10.125 □ 14
- Art. 10.125.01 □ 16
- Art. 10.125.02 □ 12
- Art. 10.126 Ø 16
- Art. 10.126.01 Ø 14
- Art. 10.126.02 Ø 12

H.950 mm.

- Art. 10.133 □ 14
- Art. 10.133.01 □ 16
- Art. 10.133.02 □ 12
- Art. 10.134 Ø 16
- Art. 10.134.01 Ø 14
- Art. 10.134.02 Ø 12

H.950 mm.

- Art. 10.141 □ 14
- Art. 10.141.01 □ 16
- Art. 10.141.02 □ 12
- Art. 10.142 Ø 16
- Art. 10.142.01 Ø 14
- Art. 10.142.02 Ø 12

H.1000 mm.

- Art. 10.127 □ 14
- Art. 10.127.01 □ 16
- Art. 10.127.02 □ 12
- Art. 10.128 Ø 16
- Art. 10.128.01 Ø 14
- Art. 10.128.02 Ø 12

H.1000 mm.

- Art. 10.135 □ 14
- Art. 10.135.01 □ 16
- Art. 10.135.02 □ 12
- Art. 10.136 Ø 16
- Art. 10.136.01 Ø 14
- Art. 10.136.02 Ø 12

H.1000 mm.

- Art. 10.143 □ 14
- Art. 10.143.01 □ 16
- Art. 10.143.02 □ 12
- Art. 10.144 Ø 16
- Art. 10.144.01 Ø 14
- Art. 10.144.02 Ø 12

H.1200 mm.

- Art. 10.129 □ 14
- Art. 10.129.01 □ 16
- Art. 10.129.02 □ 12
- Art. 10.130 Ø 16
- Art. 10.130.01 Ø 14
- Art. 10.130.02 Ø 12

H.1200 mm.

- Art. 10.137 □ 14
- Art. 10.137.01 □ 16
- Art. 10.137.02 □ 12
- Art. 10.138 Ø 16
- Art. 10.138.01 Ø 14
- Art. 10.138.02 Ø 12

H.1200 mm.

- Art. 10.145 □ 14
- Art. 10.145.01 □ 16
- Art. 10.145.02 □ 12
- Art. 10.146 Ø 16
- Art. 10.146.01 Ø 14
- Art. 10.146.02 Ø 12

H.1500 mm.

- Art. 10.131 □ 14
- Art. 10.131.01 □ 16
- Art. 10.131.02 □ 12
- Art. 10.132 Ø 16
- Art. 10.132.01 Ø 14
- Art. 10.132.02 Ø 12

H.1500 mm.

- Art. 10.139 □ 14
- Art. 10.139.01 □ 16
- Art. 10.139.02 □ 12
- Art. 10.140 Ø 16
- Art. 10.140.01 Ø 14
- Art. 10.140.02 Ø 12

H.1500 mm.

- Art. 10.147 □ 14
- Art. 10.147.01 □ 16
- Art. 10.147.02 □ 12
- Art. 10.148 Ø 16
- Art. 10.148.01 Ø 14
- Art. 10.148.02 Ø 12

Martellato
Hammered

H.950 mm.

- Art. 10.148.03 □ 12
- Art. 10.148.04 □ 14
- Art. 10.148.05 □ 16

H.1000 mm.

- Art. 10.148.06 □ 12
- Art. 10.148.07 □ 14
- Art. 10.148.08 □ 16

H.1200 mm.

- Art. 10.148.09 □ 12
- Art. 10.148.10 □ 14
- Art. 10.148.11 □ 16

H.1500 mm.

- Art. 10.148.12 □ 12
- Art. 10.148.13 □ 14
- Art. 10.148.14 □ 16

H.950 mm.

- Art. 10.148.50 □ 12
- Art. 10.148.51 □ 14
- Art. 10.148.52 □ 16

H.1000 mm.

- Art. 10.148.53 □ 12
- Art. 10.148.54 □ 14
- Art. 10.148.55 □ 16

H.1200 mm.

- Art. 10.148.56 □ 12
- Art. 10.148.57 □ 14
- Art. 10.148.58 □ 16

H.1500 mm.

- Art. 10.148.59 □ 12
- Art. 10.148.60 □ 14
- Art. 10.148.61 □ 16

NEW

PALLINE PICCOLE / SMALL BALLS

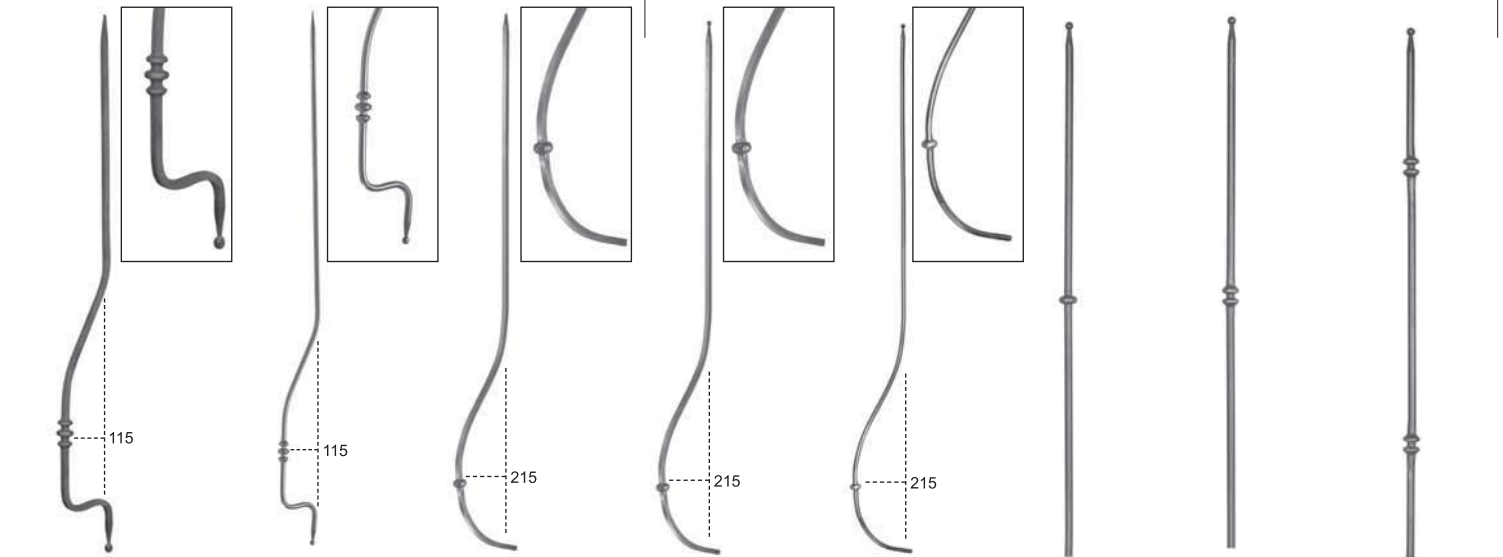

Tondo / Round		Tondo / Round		Tondo / Round		Tondo / Round		Tondo / Round	
H.950 mm.	H.950 mm.	H.1000 mm.	H.1000 mm.	H.1000 mm.	H.950 mm.	H.950 mm.	H.950 mm.	H.950 mm.	H.950 mm.
Art. 10.149 □ 14	Art. 10.152.03 Ø 14	Art. 10.152.41 □ 12	Art. 10.152.11 □ 12	Art. 10.152.23 Ø 12	Art. 10.153 Ø 12	Art. 10.165 Ø 12	Art. 10.177 Ø 12	Art. 10.177 Ø 12	Art. 10.177 Ø 12
Art. 10.149.01 □ 16	Art. 10.152.04 Ø 16	Art. 10.152.42 □ 14	Art. 10.152.12 □ 14	Art. 10.152.24 Ø 16	Art. 10.154 Ø 14	Art. 10.166 Ø 14	Art. 10.178 Ø 14	Art. 10.178 Ø 14	Art. 10.178 Ø 14
Art. 10.149.02 □ 12			Art. 10.152.13 □ 16		Art. 10.155 Ø 16	Art. 10.167 Ø 16	Art. 10.179 Ø 16	Art. 10.179 Ø 16	Art. 10.179 Ø 16
H.1000 mm.	H.1200 mm.	H.1600 mm.	H.1200 mm.	H.1200 mm.	H.1000 mm.	H.1000 mm.	H.1000 mm.	H.1000 mm.	H.1000 mm.
Art. 10.150 □ 14	Art. 10.152.05 Ø 14	Art. 10.152.55 □ 14	Art. 10.152.14 □ 12	Art. 10.152.25 Ø 14	Art. 10.156 Ø 12	Art. 10.168 Ø 12	Art. 10.180 Ø 12	Art. 10.180 Ø 12	Art. 10.180 Ø 12
Art. 10.150.01 □ 16	Art. 10.152.06 Ø 16		Art. 10.152.15 □ 14	Art. 10.152.26 Ø 16	Art. 10.157 Ø 14	Art. 10.169 Ø 14	Art. 10.181 Ø 14	Art. 10.181 Ø 14	Art. 10.181 Ø 14
Art. 10.150.02 □ 12	H.1500 mm.	H.1700 mm.	Art. 10.152.16 □ 16	Art. 10.152.27 Ø 14	Art. 10.158 Ø 16	Art. 10.170 Ø 16	Art. 10.182 Ø 16	Art. 10.182 Ø 16	Art. 10.182 Ø 16
H.1200 mm.	Art. 10.152.07 Ø 14	H.1800 mm.	Art. 10.152.17 □ 12	Art. 10.152.28 Ø 16	H.1200 mm.	H.1200 mm.	H.1200 mm.	H.1200 mm.	H.1200 mm.
Art. 10.151 □ 14	Art. 10.152.08 Ø 16		Art. 10.152.18 □ 14	Art. 10.152.29 Ø 14	Art. 10.159 Ø 12	Art. 10.171 Ø 12	Art. 10.183 Ø 12	Art. 10.183 Ø 12	Art. 10.183 Ø 12
Art. 10.151.01 □ 16	H.1800 mm.		Art. 10.152.19 □ 16	Art. 10.152.30 Ø 16	Art. 10.160 Ø 14	Art. 10.172 Ø 14	Art. 10.184 Ø 14	Art. 10.184 Ø 14	Art. 10.184 Ø 14
Art. 10.151.02 □ 12	Art. 10.152.09 Ø 14		Art. 10.152.20 □ 12		Art. 10.161 Ø 16	Art. 10.173 Ø 16	Art. 10.185 Ø 16	Art. 10.185 Ø 16	Art. 10.185 Ø 16
H.1500 mm.	Art. 10.152.10 Ø 16		Art. 10.152.21 □ 14		H.1500 mm.	H.1500 mm.	H.1500 mm.	H.1500 mm.	H.1500 mm.
Art. 10.152 □ 14			Art. 10.152.22 □ 16		Art. 10.162 Ø 12	Art. 10.174 Ø 12	Art. 10.186 Ø 12	Art. 10.186 Ø 12	Art. 10.186 Ø 12
Art. 10.152.01 □ 16					Art. 10.163 Ø 14	Art. 10.175 Ø 14	Art. 10.187 Ø 14	Art. 10.187 Ø 14	Art. 10.187 Ø 14
Art. 10.152.02 □ 12					Art. 10.164 Ø 16	Art. 10.176 Ø 16	Art. 10.188 Ø 16	Art. 10.188 Ø 16	Art. 10.188 Ø 16

PALLINE PICCOLE / SMALL BALLS

Tondo / Round		Tondo / Round		Tondo / Round		Tondo / Round		Tondo / Round		Tondo / Round	
H.950 mm.	H.950 mm.	H.950 mm.	H.950 mm.	H.950 mm.	H.950 mm.	H.950 mm.	H.950 mm.	H.950 mm.	H.950 mm.	H.950 mm.	H.950 mm.
Art. 10.189 □ 12	Art. 10.201 Ø 12	Art. 10.213 □ 12	Art. 10.216 □ 12	Art. 10.225 □ 12	Art. 10.228 □ 12	Art. 10.237 □ 12	Art. 10.249 □ 12	Art. 10.252 □ 12	Art. 10.261 □ 12	Art. 10.264 □ 12	Art. 10.267 □ 12
Art. 10.190 Ø 14	Art. 10.202 Ø 14	Art. 10.214 □ 14	Art. 10.220 □ 14	Art. 10.226 □ 14	Art. 10.232 □ 14	Art. 10.238 □ 14	Art. 10.250 □ 14	Art. 10.256 □ 14	Art. 10.262 □ 14	Art. 10.268 □ 14	Art. 10.270 □ 14
Art. 10.191 Ø 16	Art. 10.203 Ø 16	Art. 10.215 □ 16	Art. 10.221 □ 16	Art. 10.227 □ 16	Art. 10.233 □ 16	Art. 10.239 □ 16	Art. 10.251 □ 16	Art. 10.257 □ 16	Art. 10.263 □ 16	Art. 10.269 □ 16	Art. 10.271 □ 14
H.1000 mm.	H.1000 mm.	H.1000 mm.	H.1000 mm.	H.1000 mm.	H.1000 mm.	H.1000 mm.	H.1000 mm.	H.1000 mm.	H.1000 mm.	H.1000 mm.	H.1000 mm.
Art. 10.192 Ø 12	Art. 10.204 Ø 12	Art. 10.217 □ 14	Art. 10.222 □ 12	Art. 10.229 □ 14	Art. 10.234 □ 12	Art. 10.240 □ 12	Art. 10.253 □ 14	Art. 10.259 □ 14	Art. 10.265 □ 14	Art. 10.272 □ 16	Art. 10.272 □ 16
Art. 10.193 Ø 14	Art. 10.205 Ø 14	Art. 10.218 □ 16	Art. 10.223 □ 14	Art. 10.230 □ 16	Art. 10.235 □ 14	Art. 10.241 □ 14	Art. 10.254 □ 16	Art. 10.260 □ 14	Art. 10.266 □ 16		
Art. 10.194 Ø 16	Art. 10.206 Ø 16		Art. 10.224 □ 16		Art. 10.236 □ 16	Art. 10.242 □ 16	Art. 10.255 □ 12	Art. 10.261 □ 12	Art. 10.267 □ 12		
H.1200 mm.	H.1200 mm.	H.1200 mm.	H.1200 mm.	H.1200 mm.	H.1200 mm.	H.1200 mm.	H.1200 mm.	H.1200 mm.	H.1200 mm.	H.1200 mm.	H.1200 mm.
Art. 10.195 Ø 12	Art. 10.207 Ø 12	Art. 10.219 □ 12	Art. 10.225 □ 12	Art. 10.231 □ 12	Art. 10.237 □ 12	Art. 10.243 □ 12	Art. 10.256 □ 14	Art. 10.262 □ 14	Art. 10.268 □ 14	Art. 10.274 □ 16	Art. 10.274 □ 16
Art. 10.196 Ø 14	Art. 10.208 Ø 14	Art. 10.220 □ 14	Art. 10.226 □ 14	Art. 10.232 □ 14	Art. 10.238 □ 14	Art. 10.244 □ 14	Art. 10.257 □ 16	Art. 10.263 □ 16	Art. 10.269 □ 16		
Art. 10.197 Ø 16	Art. 10.209 Ø 16		Art. 10.233 □ 16		Art. 10.239 □ 16	Art. 10.245 □ 16	Art. 10.264 □ 12	Art. 10.270 □ 12	Art. 10.276 □ 16		
H.1500 mm.	H.1500 mm.	H.1500 mm.	H.1500 mm.	H.1500 mm.	H.1500 mm.	H.1500 mm.	H.1500 mm.	H.1500 mm.	H.1500 mm.	H.1500 mm.	H.1500 mm.
Art. 10.198 Ø 12	Art. 10.210 Ø 12	Art. 10.222 □ 12	Art. 10.228 □ 12	Art. 10.234 □ 12	Art. 10.240 □ 12	Art. 10.246 □ 12	Art. 10.259 □ 14	Art. 10.265 □ 14	Art. 10.271 □ 14	Art. 10.277 □ 16	Art. 10.277 □ 16
Art. 10.199 Ø 14	Art. 10.211 Ø 14	Art. 10.223 □ 14	Art. 10.229 □ 14	Art. 10.235 □ 14	Art. 10.241 □ 14	Art. 10.247 □ 14	Art. 10.266 □ 12	Art. 10.272 □ 16	Art. 10.278 □ 16		
Art. 10.200 Ø 16	Art. 10.212 Ø 16	Art. 10.224 □ 16	Art. 10.230 □ 16	Art. 10.236 □ 16	Art. 10.242 □ 16	Art. 10.248 □ 16	Art. 10.267 □ 12	Art. 10.273 □ 16	Art. 10.279 □ 16		

Tutte le parti di questo catalogo - foto comprese - sono di proprietà Euro-Fer. La riproduzione, anche parziale, è vietata in ogni forma e con ogni mezzo. / Every part of this catalogue - photos included - is Euro-Fer's property. All forms of copying are strictly prohibited.

PALLINE PICCOLE / SMALL BALLS



<p>Martellato Hammered</p> <p>H.950 mm.</p> <p>Art. 10.273 □12 Art. 10.274 □14 Art. 10.275 □16</p> <p>H.1000 mm.</p> <p>Art. 10.276 □12 Art. 10.277 □14 Art. 10.278 □16</p> <p>H.1200 mm.</p> <p>Art. 10.279 □12 Art. 10.280 □14 Art. 10.281 □16</p> <p>H.1500 mm.</p> <p>Art. 10.282 □12 Art. 10.283 □14 Art. 10.284 □16</p>	<p>Martellato Hammered</p> <p>H.950 mm.</p> <p>Art. 10.285 □12 Art. 10.286 □14 Art. 10.287 □16</p> <p>H.1000 mm.</p> <p>Art. 10.288 □12 Art. 10.289 □14 Art. 10.290 □16</p> <p>H.1200 mm.</p> <p>Art. 10.291 □12 Art. 10.292 □14 Art. 10.293 □16</p> <p>H.1500 mm.</p> <p>Art. 10.294 □12 Art. 10.295 □14 Art. 10.296 □16</p>	<p>Martellato Hammered</p> <p>H.950 mm.</p> <p>Art. 10.297 □12 Art. 10.298 □14 Art. 10.299 □16</p> <p>H.1000 mm.</p> <p>Art. 10.300 □12 Art. 10.301 □14 Art. 10.302 □16</p> <p>H.1200 mm.</p> <p>Art. 10.303 □12 Art. 10.304 □14 Art. 10.305 □16</p> <p>H.1500 mm.</p> <p>Art. 10.306 □12 Art. 10.307 □14 Art. 10.308 □16</p>	<p>Martellato Hammered</p> <p>H.950 mm.</p> <p>Art. 10.309 □12 Art. 10.310 □14 Art. 10.311 □16</p> <p>H.1000 mm.</p> <p>Art. 10.312 □12 Art. 10.313 □14 Art. 10.314 □16</p> <p>H.1200 mm.</p> <p>Art. 10.315 □12 Art. 10.316 □14 Art. 10.317 □16</p> <p>H.1500 mm.</p> <p>Art. 10.318 □12 Art. 10.319 □14 Art. 10.320 □16</p>	<p>Martellato Hammered</p> <p>H.950 mm.</p> <p>Art. 10.321 □12 Art. 10.322 □14 Art. 10.323 □16</p> <p>H.1000 mm.</p> <p>Art. 10.324 □12 Art. 10.325 □14 Art. 10.326 □16</p> <p>H.1200 mm.</p> <p>Art. 10.327 □12 Art. 10.328 □14 Art. 10.329 □16</p> <p>H.1500 mm.</p> <p>Art. 10.330 □12 Art. 10.331 □14 Art. 10.332 □16</p>	<p>Tondo / Round</p> <p>H.950 mm.</p> <p>Art. 10.333 Ø 12 Art. 10.334 Ø 14 Art. 10.335 Ø 16</p> <p>H.1000 mm.</p> <p>Art. 10.336 Ø 12 Art. 10.337 Ø 14 Art. 10.338 Ø 16</p> <p>H.1200 mm.</p> <p>Art. 10.339 Ø 12 Art. 10.340 Ø 14 Art. 10.341 Ø 16</p> <p>H.1500 mm.</p> <p>Art. 10.342 Ø 12 Art. 10.343 Ø 14 Art. 10.344 Ø 16</p>	<p>Tondo / Round</p> <p>H.950 mm.</p> <p>Art. 10.345 Ø 12 Art. 10.346 Ø 14 Art. 10.347 Ø 16</p> <p>H.1000 mm.</p> <p>Art. 10.348 Ø 12 Art. 10.349 Ø 14 Art. 10.350 Ø 16</p> <p>H.1200 mm.</p> <p>Art. 10.351 Ø 12 Art. 10.352 Ø 14 Art. 10.353 Ø 16</p> <p>H.1500 mm.</p> <p>Art. 10.354 Ø 12 Art. 10.355 Ø 14 Art. 10.356 Ø 16</p>
---	---	---	---	---	---	---

PALLINE PICCOLE / SMALL BALLS

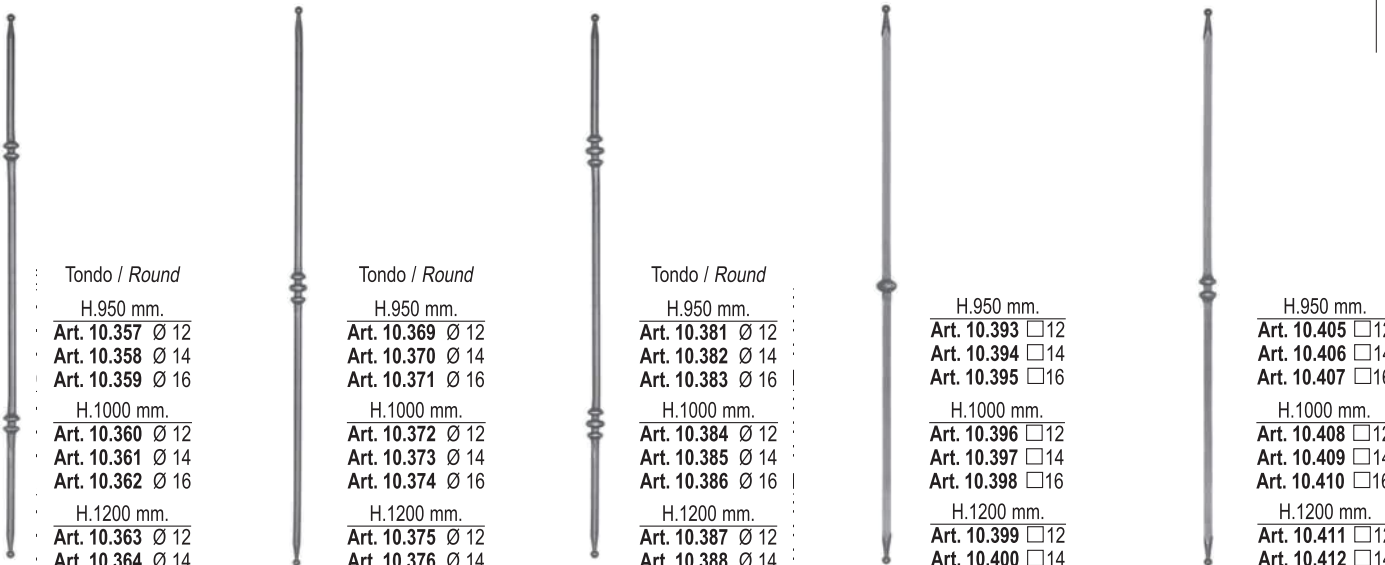

<p>Tondo / Round</p> <p>H.950 mm.</p> <p>Art. 10.357 Ø 12 Art. 10.358 Ø 14 Art. 10.359 Ø 16</p> <p>H.1000 mm.</p> <p>Art. 10.360 Ø 12 Art. 10.361 Ø 14 Art. 10.362 Ø 16</p> <p>H.1200 mm.</p> <p>Art. 10.363 Ø 12 Art. 10.364 Ø 14 Art. 10.365 Ø 16</p> <p>H.1500 mm.</p> <p>Art. 10.366 Ø 12 Art. 10.367 Ø 14 Art. 10.368 Ø 16</p>	<p>Tondo / Round</p> <p>H.950 mm.</p> <p>Art. 10.369 Ø 12 Art. 10.370 Ø 14 Art. 10.371 Ø 16</p> <p>H.1000 mm.</p> <p>Art. 10.372 Ø 12 Art. 10.373 Ø 14 Art. 10.374 Ø 16</p> <p>H.1200 mm.</p> <p>Art. 10.375 Ø 12 Art. 10.376 Ø 14 Art. 10.377 Ø 16</p> <p>H.1500 mm.</p> <p>Art. 10.378 Ø 12 Art. 10.379 Ø 14 Art. 10.380 Ø 16</p>	<p>Tondo / Round</p> <p>H.950 mm.</p> <p>Art. 10.381 Ø 12 Art. 10.382 Ø 14 Art. 10.383 Ø 16</p> <p>H.1000 mm.</p> <p>Art. 10.384 Ø 12 Art. 10.385 Ø 14 Art. 10.386 Ø 16</p> <p>H.1200 mm.</p> <p>Art. 10.387 Ø 12 Art. 10.388 Ø 14 Art. 10.389 Ø 16</p> <p>H.1500 mm.</p> <p>Art. 10.390 Ø 12 Art. 10.391 Ø 14 Art. 10.392 Ø 16</p>	<p>H.950 mm.</p> <p>Art. 10.393 □12 Art. 10.394 □14 Art. 10.395 □16</p> <p>H.1000 mm.</p> <p>Art. 10.396 □12 Art. 10.397 □14 Art. 10.398 □16</p> <p>H.1200 mm.</p> <p>Art. 10.399 □12 Art. 10.400 □14 Art. 10.401 □16</p> <p>H.1500 mm.</p> <p>Art. 10.402 □12 Art. 10.403 □14 Art. 10.404 □16</p>	<p>H.950 mm.</p> <p>Art. 10.405 □12 Art. 10.406 □14 Art. 10.407 □16</p> <p>H.1000 mm.</p> <p>Art. 10.408 □12 Art. 10.409 □14 Art. 10.410 □16</p> <p>H.1200 mm.</p> <p>Art. 10.411 □12 Art. 10.412 □14 Art. 10.413 □16</p> <p>H.1500 mm.</p> <p>Art. 10.414 □12 Art. 10.415 □14 Art. 10.416 □16</p>
---	---	---	--	--

Tutte le parti di questo catalogo - foto comprese - sono di proprietà Euro-Fer. La riproduzione, anche parziale, è vietata in ogni forma e con ogni mezzo. / Every part of this catalogue - photos included - is Euro-Fer's property. All forms of copying are strictly prohibited.

PALLINE PICCOLE / SMALL BALLS



H.950 mm.
Art. 10.417 □12
Art. 10.418 □14
Art. 10.419 □16

H.950 mm.
Art. 10.429 □12
Art. 10.430 □14
Art. 10.431 □16

H.950 mm.
Art. 10.441 □12
Art. 10.442 □14
Art. 10.443 □16

Martellato
Hammered
H.950 mm.
Art. 10.453 □12
Art. 10.454 □14
Art. 10.455 □16

Martellato
Hammered
H.950 mm.
Art. 10.465 □12
Art. 10.466 □14
Art. 10.467 □16

Martellato
Hammered
H.950 mm.
Art. 10.477 □12
Art. 10.478 □14
Art. 10.479 □16

Martellato
Hammered
H.950 mm.
Art. 10.489 □12
Art. 10.490 □14
Art. 10.491 □16

H.1000 mm.
Art. 10.420 □12
Art. 10.421 □14
Art. 10.422 □16

H.1000 mm.
Art. 10.432 □12
Art. 10.433 □14
Art. 10.434 □16

H.1000 mm.
Art. 10.444 □12
Art. 10.445 □14
Art. 10.446 □16

H.1000 mm.
Art. 10.456 □12
Art. 10.457 □14
Art. 10.458 □16

H.1000 mm.
Art. 10.468 □12
Art. 10.469 □14
Art. 10.470 □16

H.1000 mm.
Art. 10.480 □12
Art. 10.481 □14
Art. 10.482 □16

H.1000 mm.
Art. 10.492 □12
Art. 10.493 □14
Art. 10.494 □16

H.1200 mm.
Art. 10.423 □12
Art. 10.424 □14
Art. 10.425 □16

H.1200 mm.
Art. 10.435 □12
Art. 10.436 □14
Art. 10.437 □16

H.1200 mm.
Art. 10.447 □12
Art. 10.448 □14
Art. 10.449 □16

H.1200 mm.
Art. 10.459 □12
Art. 10.460 □14
Art. 10.461 □16

H.1200 mm.
Art. 10.471 □12
Art. 10.472 □14
Art. 10.473 □16

H.1200 mm.
Art. 10.483 □12
Art. 10.484 □14
Art. 10.485 □16

H.1200 mm.
Art. 10.495 □12
Art. 10.496 □14
Art. 10.497 □16

H.1500 mm.
Art. 10.426 □12
Art. 10.427 □14
Art. 10.428 □16

H.1500 mm.
Art. 10.438 □12
Art. 10.439 □14
Art. 10.440 □16

H.1500 mm.
Art. 10.450 □12
Art. 10.451 □14
Art. 10.452 □16

H.1500 mm.
Art. 10.462 □12
Art. 10.463 □14
Art. 10.464 □16

H.1500 mm.
Art. 10.474 □12
Art. 10.475 □14
Art. 10.476 □16

H.1500 mm.
Art. 10.486 □12
Art. 10.487 □14
Art. 10.488 □16

H.1500 mm.
Art. 10.498 □12
Art. 10.499 □14
Art. 10.500 □16

PALLINE PICCOLE / SMALL BALLS



Martellato
Hammered

H.950 mm.
Art. 10.501 □12
Art. 10.502 □14
Art. 10.503 □16

H.1000 mm.
Art. 10.504 □12
Art. 10.505 □14
Art. 10.506 □16

H.1200 mm.
Art. 10.507 □12
Art. 10.508 □14
Art. 10.509 □16

H.1500 mm.
Art. 10.510 □12
Art. 10.511 □14
Art. 10.512 □16

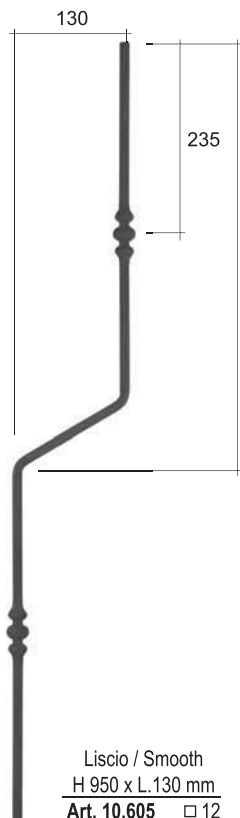
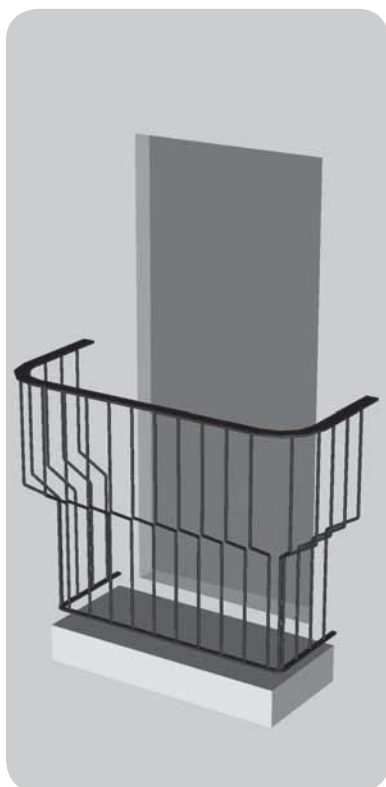

Nuovi ricalcati corteccia e rigati martellati / *New forged bars bark model and fluted hammered*



Corteccia / *Bark model*
H.950 mm

- Art. 10.001.CO Ø 16
Art. 10.001.01.CO Ø 14
Art. 10.001.02.CO Ø 12
Art. 10.013.CO □ 14
Art. 10.013.01.CO □ 16
Art. 10.013.02.CO □ 12
H.1000 mm
Art. 10.002.CO Ø 16
Art. 10.002.01.CO Ø 14
Art. 10.002.02.CO Ø 12
Art. 10.014.CO □ 14
Art. 10.014.01.CO □ 16
Art. 10.014.02.CO □ 12

- Rigato Martellato /
Fluted Hammered
H.950 mm
Art. 10.013.RM □ 14
Art. 10.013.01.RM □ 16
Art. 10.013.02.RM □ 12



Corteccia / *Bark model*
H.950 mm

- Art. 10.040.15.CO □ 12
Art. 10.040.16.CO □ 14
Art. 10.040.17.CO □ 16
H.1000 mm
Art. 10.040.18.CO □ 12
Art. 10.040.19.CO □ 14
Art. 10.040.20.CO □ 16
Rigato Martellato /
Fluted Hammered
H.950 mm
Art. 10.040.15.RM □ 12
Art. 10.040.16.RM □ 14
Art. 10.040.17.RM □ 16



Corteccia / *Bark model*
H.950 mm

- Art. 10.005.CO Ø 16
Art. 10.005.01.CO Ø 14
Art. 10.005.02.CO Ø 12
Art. 10.017.CO □ 14
Art. 10.017.01.CO □ 16
Art. 10.017.02.CO □ 12
H.1000 mm
Art. 10.006.CO Ø 16
Art. 10.006.01.CO Ø 14
Art. 10.006.02.CO Ø 12
Art. 10.018.CO □ 14
Art. 10.018.01.CO □ 16
Art. 10.018.02.CO □ 12

- Rigato Martellato /
Fluted Hammered
H.950 mm
Art. 10.017.RM □ 14
Art. 10.017.01.RM □ 16
Art. 10.017.02.RM □ 12



Corteccia / *Bark model*
H.950 mm

- Art. 10.009.CO Ø 16
Art. 10.009.01.CO Ø 14
Art. 10.009.02.CO Ø 12
Art. 10.021.CO □ 14
Art. 10.021.01.CO □ 16
Art. 10.021.02.CO □ 12
H.1000 mm
Art. 10.010.CO Ø 16
Art. 10.010.01.CO Ø 14
Art. 10.010.02.CO Ø 12
Art. 10.022.CO □ 14
Art. 10.022.01.CO □ 16
Art. 10.022.02.CO □ 12

- Rigato Martellato /
Fluted Hammered
H.950 mm
Art. 10.021.RM □ 14
Art. 10.021.01.RM □ 16
Art. 10.021.02.RM □ 12



Corteccia / *Bark model*
H.950 mm

- Art. 10.026.CO Ø 16
Art. 10.026.01.CO Ø 14
Art. 10.026.02.CO Ø 12
Art. 10.025.CO □ 14
Art. 10.025.01.CO □ 16
Art. 10.025.02.CO □ 12
H.1000 mm
Art. 10.028.CO Ø 16
Art. 10.028.01.CO Ø 14
Art. 10.028.02.CO Ø 12
Art. 10.027.CO □ 14
Art. 10.027.01.CO □ 16
Art. 10.027.02.CO □ 12

- Rigato Martellato /
Fluted Hammered
H.950 mm
Art. 10.025.RM □ 14
Art. 10.025.01.RM □ 16
Art. 10.025.02.RM □ 12



Corteccia / *Bark model*
H.950 mm

- Art. 10.034.CO Ø 16
Art. 10.034.01.CO Ø 14
Art. 10.034.02.CO Ø 12
Art. 10.033.CO □ 14
Art. 10.033.01.CO □ 16
Art. 10.033.02.CO □ 12
H.1000 mm
Art. 10.036.CO Ø 16
Art. 10.036.01.CO Ø 14
Art. 10.036.02.CO Ø 12
Art. 10.035.CO □ 14
Art. 10.035.01.CO □ 16
Art. 10.035.02.CO □ 12

- Rigato Martellato /
Fluted Hammered
H.950 mm
Art. 10.033.RM □ 14
Art. 10.033.01.RM □ 16
Art. 10.033.02.RM □ 12



RM
rigati martellati
fluted hammered



CO
corteccia
bark model



CO
corteccia
bark model



CO
corteccia
bark model



CO
corteccia
bark model



CO
corteccia
bark model

Tutte le parti di questo catalogo - foto comprese - sono di proprietà Euro-Fer. La riproduzione, anche parziale, è vietata in ogni forma e con ogni mezzo. / Every part of this catalogue - photos included - is Euro-Fer's property. All forms of copying are strictly prohibited.

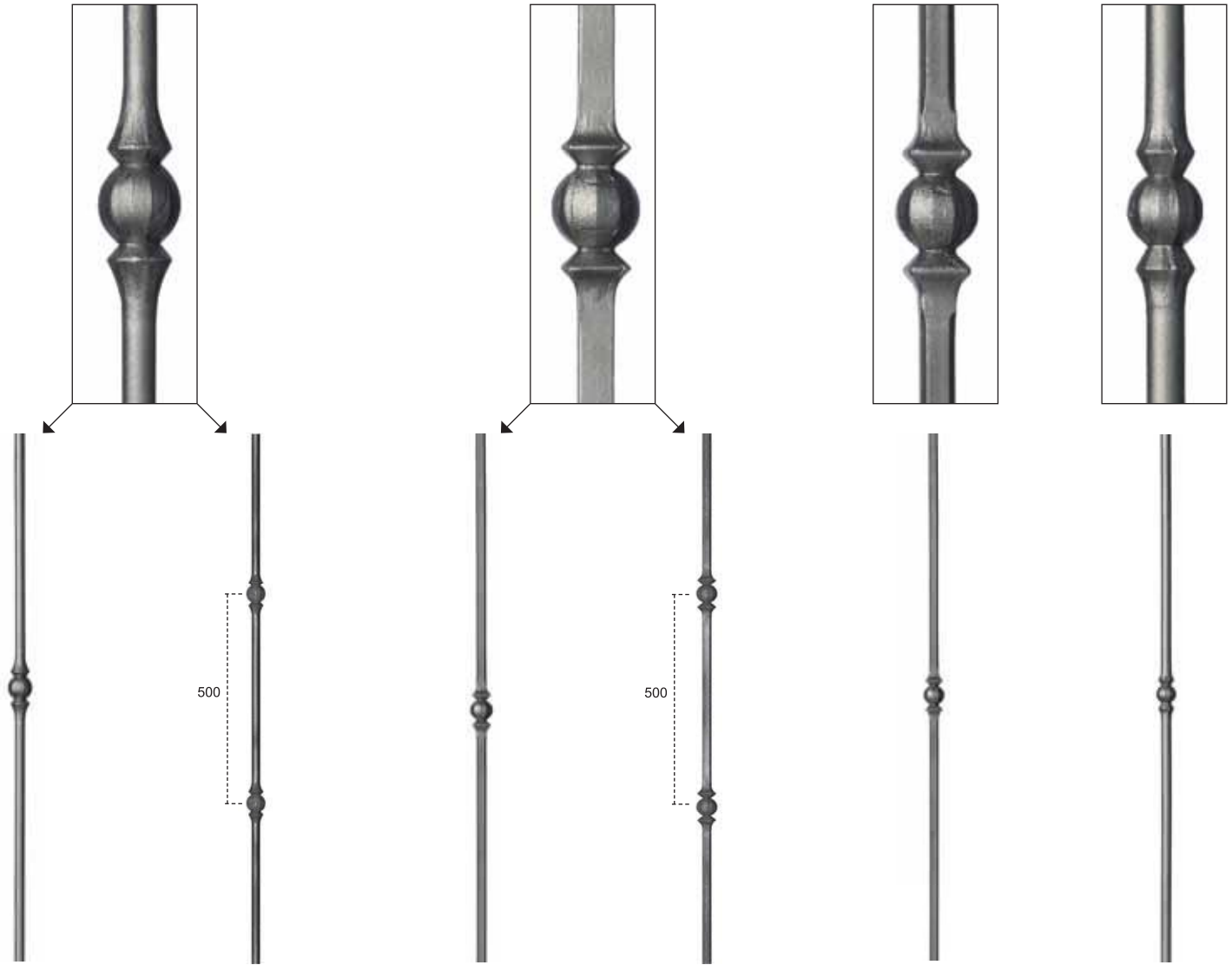

Art.11001L.T12.950
Art.11001L.T12.1000
Art.11001L.T12.1200
Art.11001L.T12.1500

Art.11001.01L.T12.1000
Art.11001.01L.T14.1000
Art.11001.01L.T16.1000

Art.11001L.T14.950
Art.11001L.T14.1000
Art.11001L.T14.1200
Art.11001L.T14.1500

Art.11001L.T16.950
Art.11001L.T16.1000
Art.11001L.T16.1200
Art.11001L.T16.1500

Art.11002L.Q12.950
Art.11002F.Q12.950
Art.11002M.Q12.950

Art.11002L.Q12.1000
Art.11002F.Q12.1000
Art.11002M.Q12.1000

Art.11002L.Q12.1200
Art.11002F.Q12.1200
Art.11002M.Q12.1200

Art.11002L.Q12.1500
Art.11002F.Q12.1500
Art.11002M.Q12.1500

Art.11002L.Q14.950
Art.11002F.Q14.950
Art.11002M.Q14.950

Art.11002L.Q14.1000
Art.11002F.Q14.1000
Art.11002M.Q14.1000

Art.11002L.Q14.1200
Art.11002F.Q14.1200
Art.11002M.Q14.1200

Art.11002L.Q14.1500
Art.11002F.Q14.1500
Art.11002M.Q14.1500

Art.11002L.Q16.950
Art.11002L.Q16.1000

Art.11002L.Q16.1200
Art.11002L.Q16.1500

Art.11003L.Q12.1000
Art.11003F.Q12.1000

Art.11003L.Q14.1000
Art.11003F.Q14.1000

Art.11003L.Q16.1000

Art.11002S.Q12.950
Art.11002S.Q12.1000
Art.11002S.Q12.1200
Art.11002S.Q12.1500

Art.11003.01L.T12.950
Art.11003.01F.T12.950

Art.11003.01L.T12.1000
Art.11003.01F.T12.1000

Art.11003.01L.T12.1200
Art.11003.01F.T12.1200

Art.11003.01L.T12.1500
Art.11003.01F.T12.1500

Art.11003.01L.T14.950
Art.11003.01L.T14.1000
Art.11003.01L.T14.1200
Art.11003.01L.T14.1500

Legenda / Legend

- Q** QUADRO / SQUARE IRON
T TONDO / ROUND IRON
F FORGIATO / FORGED
L LISCIO / SMOOTH
M MARTELLATO / HAMMERED
S SMUSSATO / BLUNTED

Le misure sono in millimetri
sizes are in mm

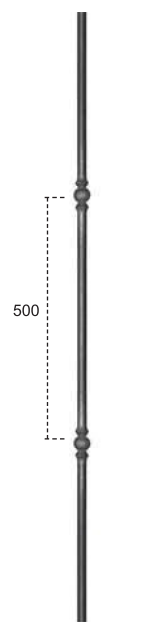

Art.11003.02L.T12.1000
Art.11003.02F.T12.1000

Art. 11004L.Q12.1000
Art. 11004L.Q12.1200
Art. 11004F.Q12.1000
Art. 11004F.Q12.1200

Art.11008L.Q12.950
Art.11008F.Q12.950
Art.11008M.Q12.950

Art.11008L.Q12.1000
Art.11008F.Q12.1000
Art.11008M.Q12.1000

Art.11008L.Q12.1200
Art.11008F.Q12.1200
Art.11008M.Q12.1200

Art.11008L.Q12.1500
Art.11008F.Q12.1500
Art.11008M.Q12.1500

Art.11008L.Q14.950
Art.11008F.Q14.950
Art.11008M.Q14.950
Art.11008L.Q14.1000
Art.11008F.Q14.1000
Art.11008M.Q14.1000

Art.11008L.Q14.1200
Art.11008F.Q14.1200
Art.11008M.Q14.1200
Art.11008L.Q14.1500
Art.11008F.Q14.1500
Art.11008M.Q14.1500

Art.11008.01L.Q12.1000
Art.11008.01F.Q12.1000
Art.11008.01M.Q12.1000

Art.11008.01L.Q14.1000
Art.11008.01F.Q14.1000
Art.11008.01M.Q14.1000

Art.11008S.Q12.950
Art.11008S.Q12.1000
Art.11008S.Q12.1200
Art.11008S.Q12.1500

Art.11008.04L.T12.950
Art.11008.04L.T12.1000
Art.11008.04L.T12.1200
Art.11008.04L.T12.1500

Art.11008.04L.T14.950
Art.11008.04L.T14.1000
Art.11008.04L.T14.1200
Art.11008.04L.T14.1500

Legenda / Legend

Q QUADRO / SQUARE IRON

T TONDO / ROUND IRON

F FORGIATO / FORGED

L LISCIO / SMOOTH

M MARTELLATO / HAMMERED

S SMUSSATO / BLUNTED

Le misure sono in millimetri
sizes are in mm

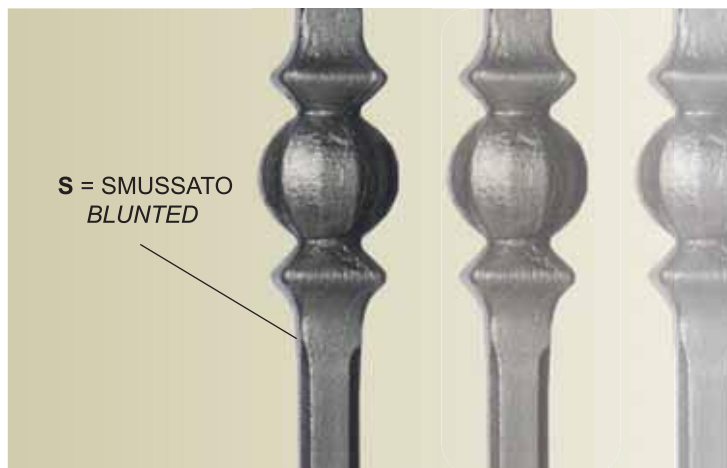



Art. 11014.10L.T12.1000
Art. 11014.10L.T12.1200
Art. 11014.10F.T12.1000
Art. 11014.10F.T12.1200

Art.11017.03L.T12.950
Art.11017.03F.T12.950

Art.11017.03L.T12.1000
Art.11017.03F.T12.1000

Art.11017.01L.T12.950
Art.11017.01F.T12.950

Art.11017.01L.T12.1000
Art.11017.01F.T12.1000

Art.11023.04L.T.12.950
Art.11023.04L.T12.1000
Art.11023.04L.T12.1200
Art.11023.04L.T12.1500

Art. 11041.36L.T12.1000
Art. 11041.36L.T12.1200
Art. 11041.36F.T12.1000
Art. 11041.36F.T12.1200

Art.11017.03L.T12.1200
Art.11017.03F.T12.1200

Art.11017.01L.T12.1200
Art.11017.01F.T12.1200

Art.11017.03L.T12.1500
Art.11017.03F.T12.1500

Art.11017.01L.T12.1500
Art.11017.01F.T12.1500

Art.11017.05L.T14.950
Art.11017.05L.T14.1000
Art.11017.05L.T14.1200
Art.11017.05L.T14.1500

Art.11017.01L.T14.950
Art.11017.01F.T14.950

Art.11017.01L.T14.1000
Art.11017.01F.T14.1000

Art.11017.01L.T14.1200
Art.11017.01F.T14.1200

Art.11017.01L.T14.1500
Art.11017.01F.T14.1500

Legenda Legend

- Q** QUADRO / SQUARE IRON
T TONDO / ROUND IRON
F FORGIATO / FORGED
L LISCIO / SMOOTH
M MARTELLATO / HAMMERED
S SMUSSATO / BLUNTED

Le misure sono in millimetri
sizes are in mm



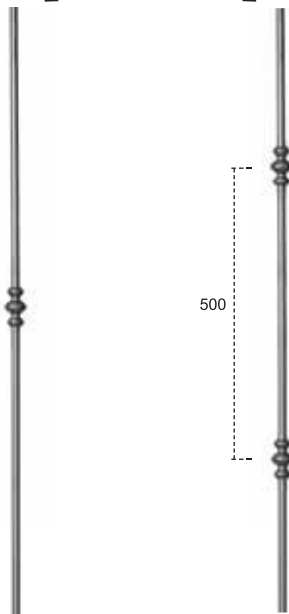

Art.11041.54L.Q12.950
Art.11041.54L.T12.950

Art.11041.55L.Q12.1000
Art.11041.55L.T12.1000

Art.11041.58L.T12.950
Art.11041.58L.Q12.950

Art.11041.60L.Q12.950
Art.11041.60L.Q12.1000

Art.11041.68L.T12.950
Art.11041.68L.T12.1000

Art.11041.70L.Q14.950
Art.11041.70L.Q14.1000
Art.11041.70L.Q14.1200
Art.11041.70L.Q14.1500

Art.11041.54L.Q12.1000
Art.11041.54L.T12.1000

Art.11041.55L.Q14.1000
Art.11041.55L.T14.1000

Art.11041.58L.T12.1000
Art.11041.58L.Q12.1000

Art.11041.54L.Q12.1200
Art.11041.54L.T12.1200

Art.11041.58L.T12.1200
Art.11041.58L.Q12.1200

Art.11041.54L.Q12.1500
Art.11041.54L.T12.1500

Art.11041.58L.T12.1500
Art.11041.58L.Q12.1500

Art.11041.54L.Q14.950
Art.11041.54L.T14.950

Art.11041.58L.T14.1000
Art.11041.58L.Q14.1000

Art.11041.54L.Q14.1000
Art.11041.54L.T14.1000

Art.11041.54L.Q14.1200
Art.11041.54L.T14.1200

Art.11041.54L.Q14.1500
Art.11041.54L.T14.1500

SU RICHIESTA / ON REQUEST

Tutti gli articoli di questo catalogo possono essere realizzati con queste lance / All articles in this catalogue can be realized with these spears.

P
PALLINA PICCOLA
SMALL BALL



A
FIAMMA
FLAME



AP
FIAMMA E PALLINA GRANDE
FLAME AND BIG BALL



PP
PUNTA A PIRAMIDE
PYRAMIDAL END



CT
CODA DI TOPO
TAIL END



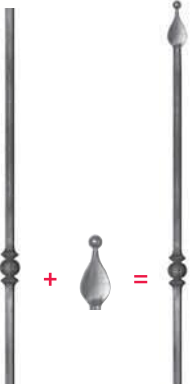

11002L.Q12.950 + AP = 11002L.Q12.950AP

Per ordinare i paletti seguire l'esempio
To order bars please follow the example:

Tutte le parti di questo catalogo - foto comprese - sono di proprietà Euro-Fer. La riproduzione, anche parziale, è vietata in ogni forma e con ogni mezzo. / Every part of this catalogue - photos included - is Euro-Fer's property. All forms of copying are strictly prohibited.



SU RICHIESTA / ON REQUEST

Tutti gli articoli di questo catalogo possono essere realizzati con queste lance / All articles in this catalogue can be realized with these spears.



P = PALLINA PICCOLA / SMALL BALL



A = FIAMMA/FLAME



AP = FIAMMA E PALLINA GRANDE / FLAME AND BIG BALL



PP = PUNTA A PIRAMIDE / PYRAMIDAL END



CT = CODA DI TOPO / TAIL END

Per ordinare i paletti seguire l'esempio / To order bars please follow the example:

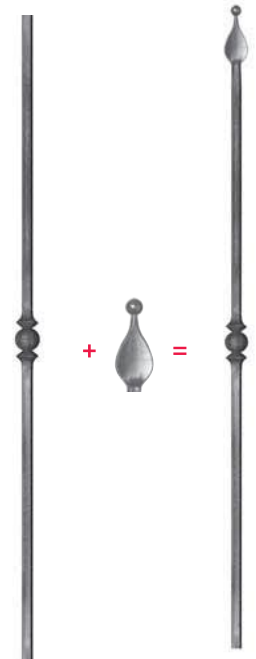

11002L.Q12.950 + AP = 11002L.Q12.950AP



Art.11098.02L.Q14.950
Art.11098.02L.Q14.1200
Art.11098.02L.Q14.1500
Art.11098.02L.Q14.1800



Art.11098.04L.T12.950
Art.11098.04L.T12.1200
Art.11098.04L.T12.1500
Art.11098.04L.T12.1800



Art.11090.01L.Q12.1000
Art.11090.01L.Q12.1200
Art.11090.01L.Q12.1500
Art.11090.01L.Q12.1800



Art.11091.01L.T12.1000
Art.11091.01L.T12.1200
Art.11091.01L.T12.1500
Art.11091.01L.T12.1800

Legenda / Legend

- Q** QUADRO / SQUARE IRON
- T** TONDO / ROUND IRON
- F** FORGIATO / FORGED
- L** LISCIIO / SMOOTH
- M** MARTELLATO / HAMMERED
- S** SMUSSATO / BLUNTED

Le misure sono in millimetri / sizes are in mm



I forgiati italiani

Il Forgiato Italiano, la ricerca della qualità assoluta.

EUROFER evolve il classico paletto forgiato standard e crea il FORGIATO ITALIANO.

Con il FORGIATO ITALIANO puoi scegliere la misura, la texture, il decoro.

È fatto interamente in Italia e ti consente di inserire il motivo in ferro forgiato su un paletto liscio, martellato o smussato.

Forged bars made in Italy

The ITALIAN FORGED BARS: the pursuit of absolute quality.

EUROFER evolves the classic standard forged bollard and creates the ITALIAN FORGED BAR.

With the ITALIAN FORGED BAR you can choose the size, the texture, the decor and the tip.

It's made entirely in Italy and allows you to insert the forged iron motif on a smooth, hammered or beveled stake.



Art. 11002P.Q12.950
Art. 11002P.Q12.1000
Art. 11002P.Q12.1200
Art. 11002P.Q12.1500
Art. 11002P.Q12.3000
Art. 11002P.Q12.6000



Art. 11002P.Q14.950
Art. 11002P.Q14.1000
Art. 11002P.Q14.1200
Art. 11002P.Q14.1500
Art. 11002P.Q14.3000
Art. 11002P.Q14.6000



Art. 11017.01P.T12.950
Art. 11017.01P.T12.1000
Art. 11017.01P.T12.1200
Art. 11017.01P.T12.1500
Art. 11017.01P.T12.3000
Art. 11017.01P.T12.6000



Art. 11017.01P.T14.950
Art. 11017.01P.T14.1000
Art. 11017.01P.T14.1200
Art. 11017.01P.T14.1500
Art. 11017.01P.T14.3000
Art. 11017.01P.T14.6000

ELEMENTI IN FERRO FORGIATO E CAPISALDI
FORGED BARS AND POSTS



H.1000 mm.
Art. 11.001
Ø 14 circa



H.1000 mm.
Art. 11.001.01
Ø 14 circa

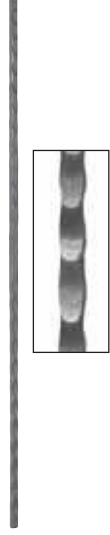

H.1000mm.
Art. 11.002.P □ 14 ca.
Art. 11.002.D.P □ 12 ca.

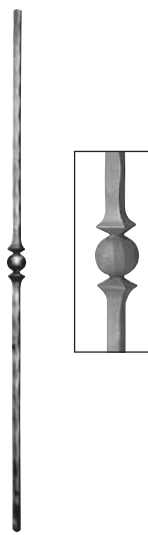

H.1000 mm.
Art. 11.002 □ 14 circa
Art. 11.002.E □ 10 circa
Art. 11.002.D □ 12 circa



H.1000 mm.
Art. 11.003 □ 14 circa
Art. 11.003.E □ 10 circa
Art. 11.003.D □ 12 circa



Rastremato / Tapered
H.1000 mm.
Art. 11.003.01.P
Ø 14 circa



H.1000 mm.
Art. 11.003.01
Ø 14 circa
Art. 11.003.01.E
Ø 12 circa



H.1000 mm.
Art. 11.003.02
Ø 14 circa
Art. 11.003.02.E
Ø 12 circa



H.1000 mm.
Art. 11.003.03
Ø 14 circa



H.1000 mm.
Art. 11.003.04
Ø 14 circa

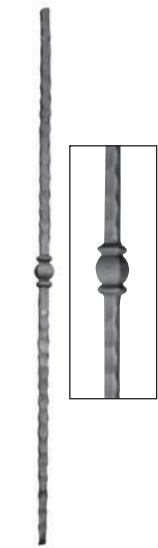

H.1000 mm.
Art. 11.004
□ 14 circa



H.1000 mm.
Art. 11.004.01
□ 14 circa

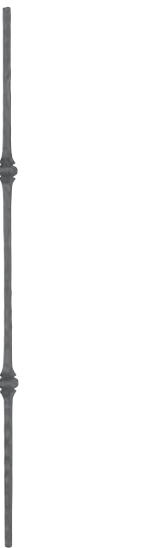

H.1000 mm.
Art. 11.004.02
□ 14 circa

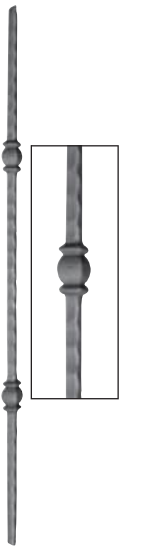

H.1000 mm.
Art. 11.005
□ 14 circa

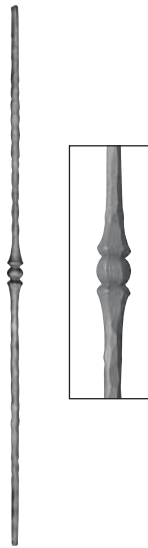

H.1000 mm.
Art. 11.006
□ 14 circa
Art. 11.006.01
Ø 14 circa



H.1000 mm.
Art. 11.007
□ 14 circa
Art. 11.007.01
Ø 14 circa



H.1000 mm.
Art. 11.008
□ 14 circa



H.1000 mm.
Art. 11.008.01
□ 14 circa

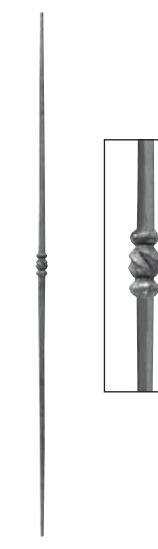

H.1000 mm.
Art. 11.008.02
Ø 14 circa



H.1000 mm.
Art. 11.008.03
Ø 14 circa



H.1000 mm.
Art. 11.008.04
Ø 12 circa



H.1000 mm.
Art. 11.008.05
Ø 12 circa



H.1000 mm
Art. 11.008.06
□ 12 circa



H.1000 mm
Art. 11.008.07
□ 12 circa

Tutte le parti di questo catalogo - foto comprese - sono di proprietà Euro-Fer. La riproduzione, anche parziale, è vietata in ogni forma e con ogni mezzo. / Every part of this catalogue - photos included - is Euro-Fer's property. All forms of copying are strictly prohibited.

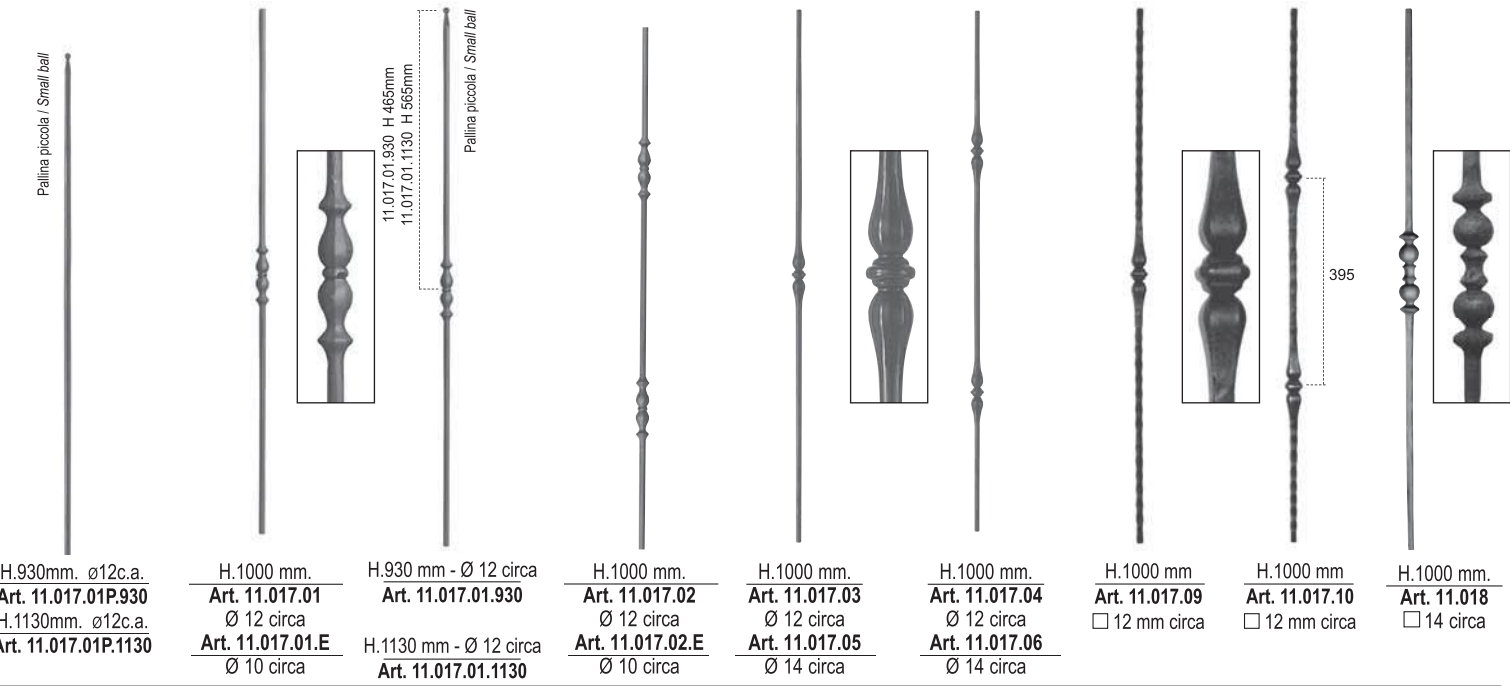
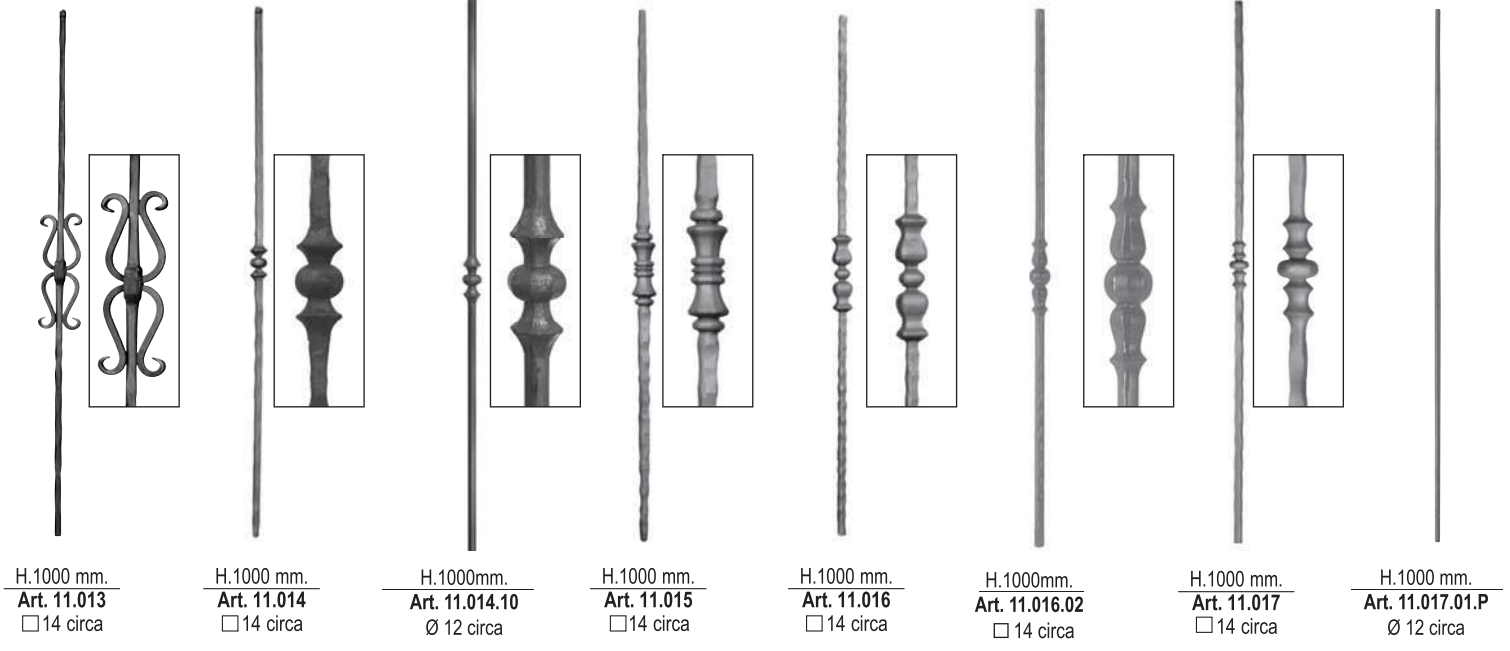
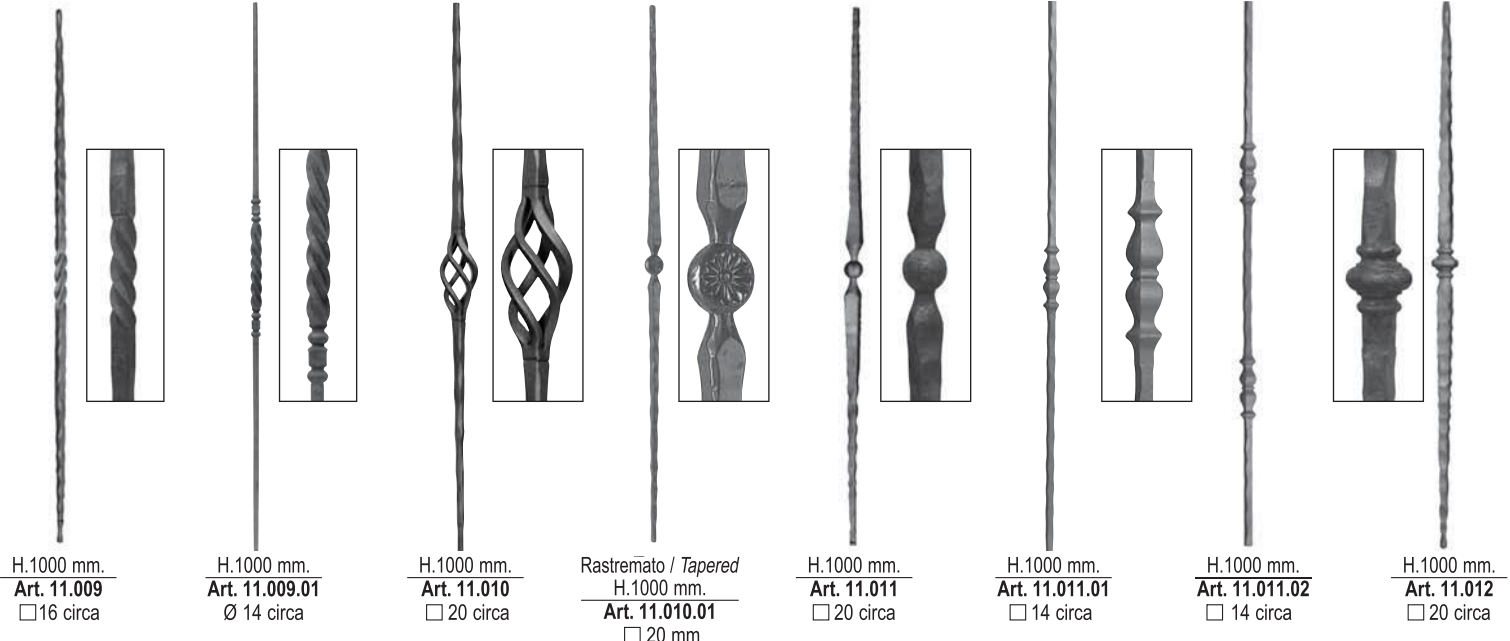

from art. 11.009 to art. 11.018

ELEMENTI IN FERRO FORGIATO E CAPISALDI
FORGED BARS AND POSTS

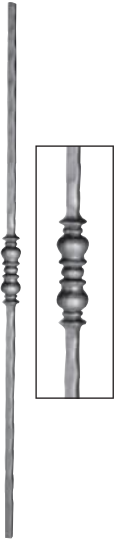

H.1000 mm.
Art. 11.019
□ 14 circa



H.1000 mm.
Art. 11.019.01
Ø 14 mm



H.1000 mm.
Art. 11.020
□ 14 circa



H.1000 mm.
Art. 11.021
□ 14 circa



H.1000 mm.
Art. 11.021.01
□ 14 circa



H.1000 mm.
Art. 11.022
□ 14 circa



H. 1000 mm
Art. 11.023
14 mm circa



H.1000 mm.
Art. 11.023.01
□ 20 circa



H. 950 mm
Art. 11.023.02
Ø 14 mm

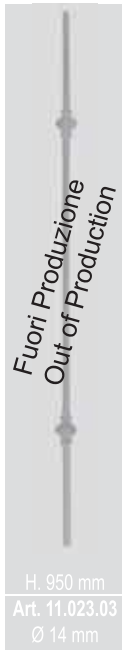

H. 950 mm
Art. 11.023.03
Ø 14 mm



H.1000 mm.
Art. 11.023.04
Ø 14 mm



H.1000 mm.
Art. 11.023.05
Ø 14 mm



H.1000 mm.
Art. 11.024
□ 14 circa



H.1000 mm.
Art. 11.025
□ 14 circa



H.1000 mm.
Art. 11.026



H.1000 mm.
Art. 11.027



H.1000 mm.
Art. 11.028



H.1000 mm.
Art. 11.029
□ 14 circa



H.1000 mm.
Art. 11.030
□ 14 circa



H.1000 mm.
Art. 11.031
□ 14 circa



H.1000 mm.
Art. 11.032
□ 14 circa



H.1000 mm.
Art. 11.033
□ 14 circa



H.1000 mm.
Art. 11.034
□ 14 circa



H.1000 mm.
Art. 11.035
□ 14 circa

Tutte le parti di questo catalogo - foto comprese - sono di proprietà Euro-Fer. La riproduzione, anche parziale, è vietata in ogni forma e con ogni mezzo. / Every part of this catalogue - photos included - is Euro-Fer's property. All forms of copying are strictly prohibited.

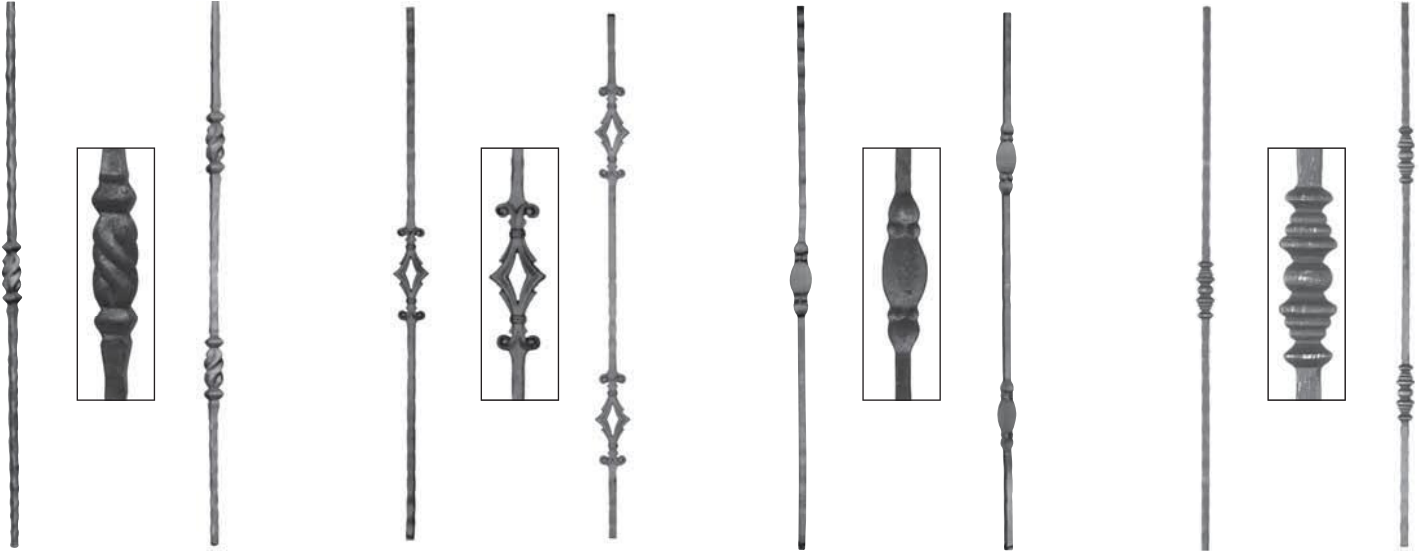

H.1000 mm. Art. 11.036 □ 14 circa
 H.1000 mm. Art. 11.037 □ 14 circa
 H.1000 mm. Art. 11.038 □ 14 circa
 H.1000 mm. Art. 11.039 □ 14 circa
 H.1000 mm. Art. 11.040 □ 12 circa
 H.1000 mm. Art. 11.041 □ 12 circa
 H.1000 mm. Art. 11.041.02 □ 14 circa
 H.1000 mm. Art. 11.041.03 □ 14 circa

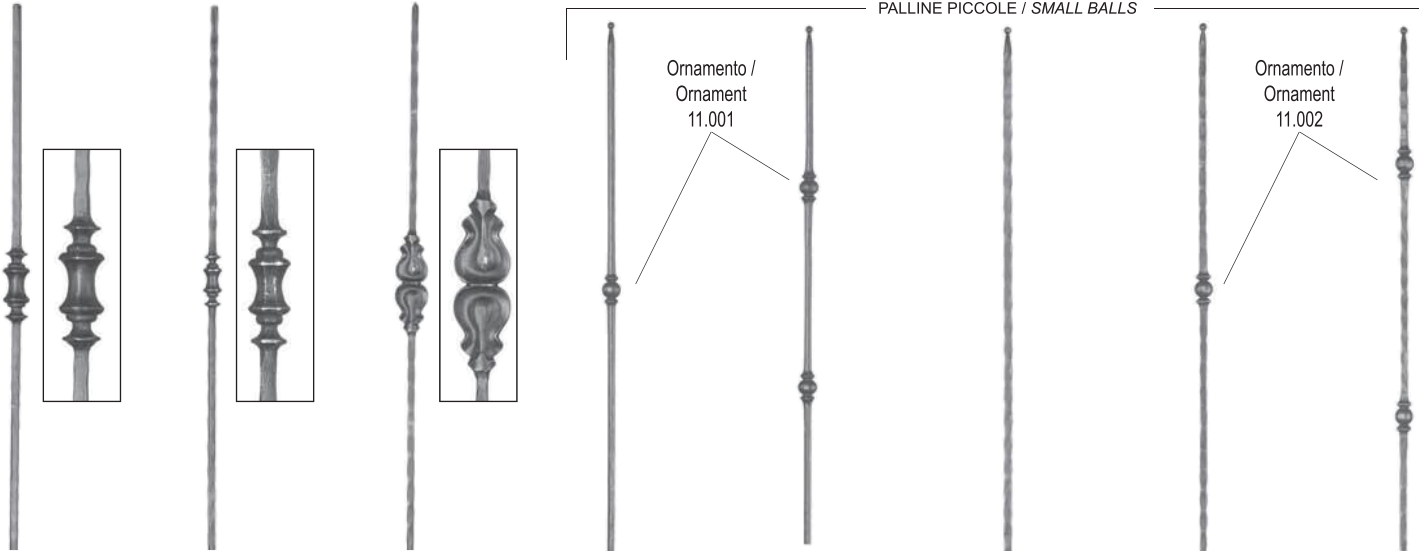

H.1000 mm. Art. 11.041.04 □ 14 circa
 H.1000 mm. Art. 11.041.05 □ 12 circa
 H.1000 mm. Art. 11.041.06 □ 12 circa
 Tondo / Round H.1000 mm. Art. 11.041.07 Ø 14 circa
 Tondo / Round H.1000 mm. Art. 11.041.08 Ø 14 circa
 H.1000 mm. Art. 11.041.09 □ 14 circa
 H.1000 mm. Art. 11.041.10 □ 14 circa
 H.1000 mm. Art. 11.041.11 □ 14 circa

PALLINE PICCOLE / SMALL BALLS

Ornamento / Ornament 11.001

Ornamento / Ornament 11.002

PALLINE PICCOLE / SMALL BALLS

Ornamento / Ornament 11.004

Ornamento / Ornament 11.008

Ornamento / Ornament 11.016

Ornamento / Ornament 11.033

Ornamento / Ornament 11.038

H.1000 mm. Art. 11.041.12 □ 14 circa
 H.1000 mm. Art. 11.041.13 □ 14 circa
 H.1000 mm. Art. 11.041.14 □ 14 circa
 H.1000 mm. Art. 11.041.15 □ 14 circa
 H.1000 mm. Art. 11.041.17 □ 14 circa
 H.1000 mm. Art. 11.041.18 □ 14 circa
 H.1000 mm. Art. 11.041.19 □ 14 circa

Tutte le parti di questo catalogo - foto comprese - sono di proprietà Euro-Fer. La riproduzione, anche parziale, è vietata in ogni forma e con ogni mezzo. / Every part of this catalogue - photos included - is Euro-Fer's property. All forms of copying are strictly prohibited.



PALLINE PICCOLE / SMALL BALLS

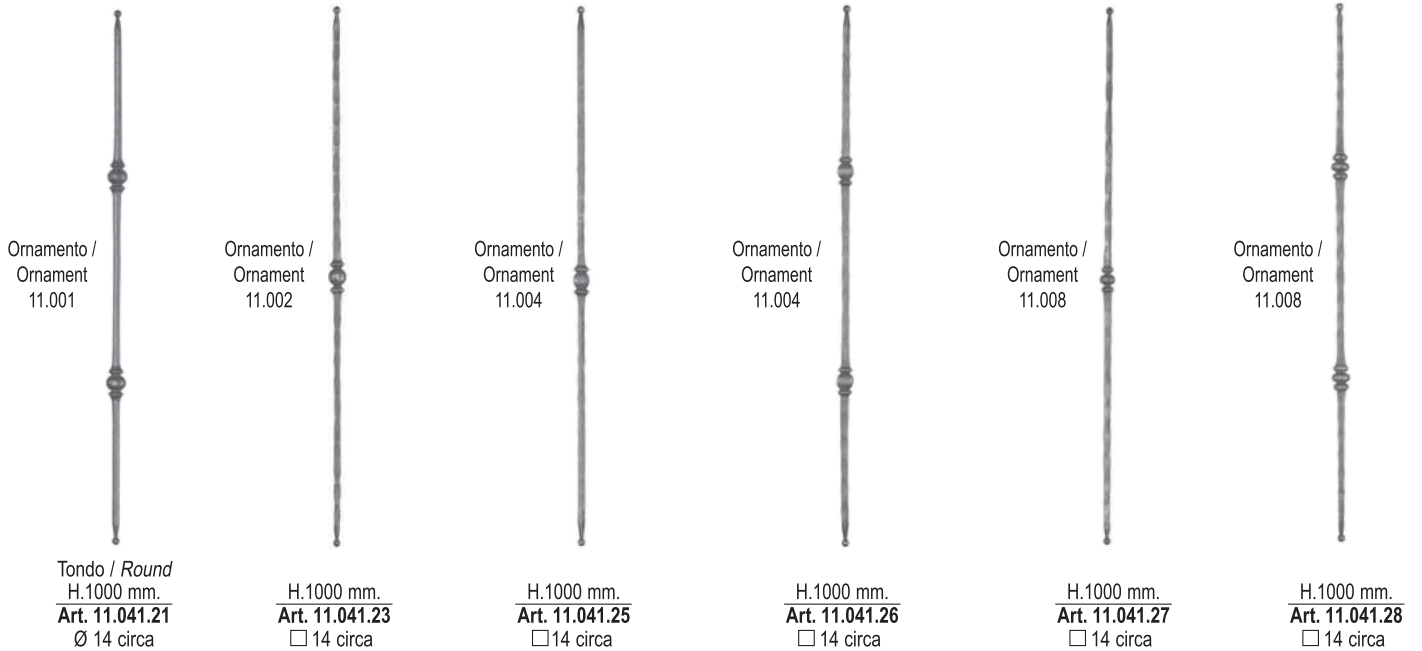

PALLINE PICCOLE / SMALL BALLS

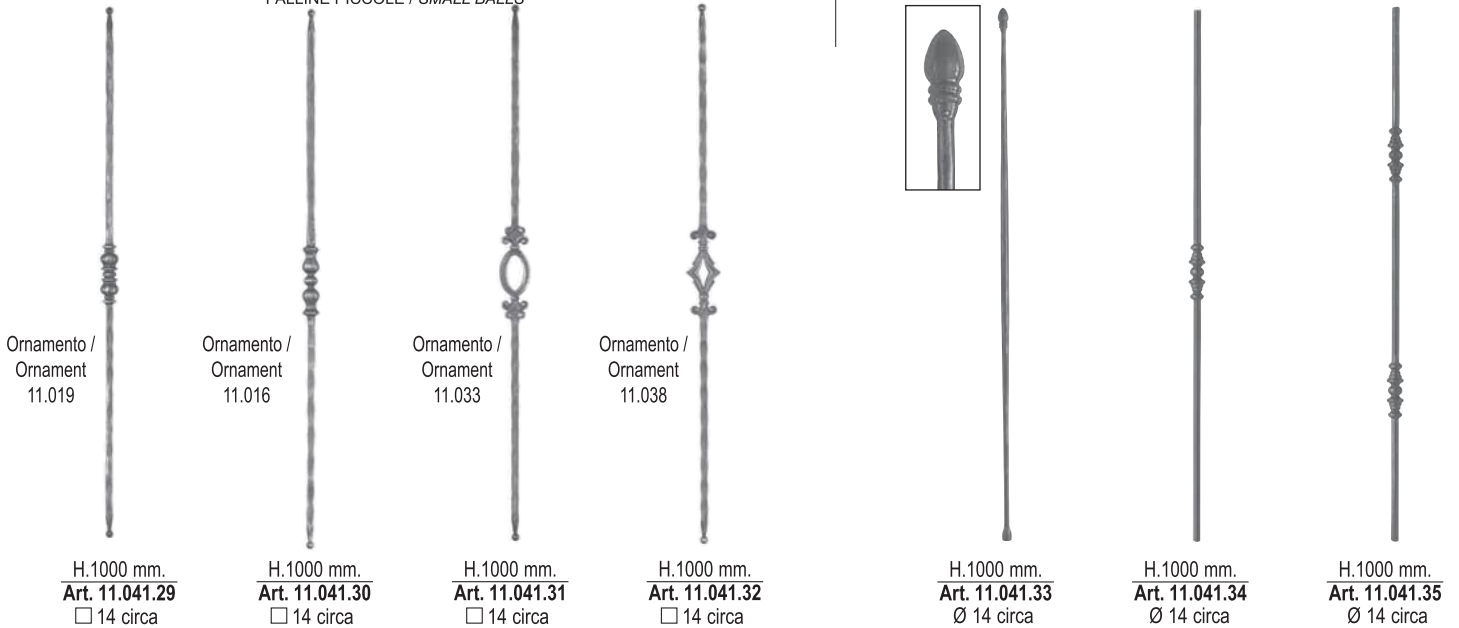

Tutte le parti di questo catalogo - foto comprese - sono di proprietà Euro-Fer. La riproduzione, anche parziale, è vietata in ogni forma e con ogni mezzo. / Every part of this catalogue - photos included - is Euro-Fer's property. All forms of copying are strictly prohibited.

ELEMENTI IN FERRO FORGIATO E CAPISALDI
FORGED BARS AND POSTS

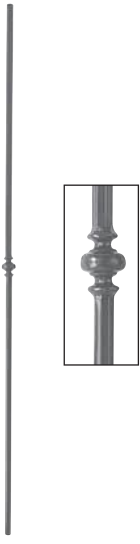

H.1000 mm.
Art. 11.041.36
Ø 12 mm circa



H.1000 mm.
Art. 11.041.37
Ø 12 mm circa



H.1000 mm.
Art. 11.041.38
□ 14 circa



H. 1000 mm
Art. 11.041.39
Ø 12 mm circa



H.1000 mm.
Art. 11.041.40
□ 14 mm circa



H. 1000 mm
Art. 11.041.41
□ 14 mm



H.1000 mm.
Art. 11.041.42
Ø 14 mm circa



H.1000 mm.
Art. 11.041.43
Ø 14 mm circa

450



H.1000 mm.
Art. 11.041.44
Ø 14 mm circa



H.1000 mm.
Art. 11.041.45
Ø 14 mm circa

400



H.1000 mm.
Art. 11.041.46
□ 14 mm circa



H.1000 mm.
Art. 11.041.47
Ø 14 mm circa



H.1000 mm.
Art. 11.041.48
Ø 14 mm circa

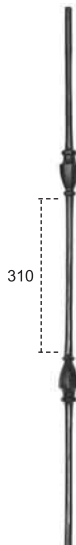

H.1000 mm.
Art. 11.041.49
Ø 14 mm circa

310

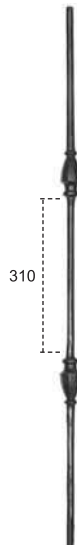

H.1000 mm.
Art. 11.041.50
Ø 14 mm circa

310



H.1000 mm.
Art. 11.041.51
Ø 14 mm circa

310



H.1000 mm
Art. 11.041.52
□ 12 mm ca.



H.1000 mm
Art. 11.041.53
□ 12 mm ca.

360



H.1000 mm
Art. 11.041.54
Ø 12 mm ca.



H.1000 mm
Art. 11.041.55
Ø 12 mm ca.

490



H.1000 mm
Art. 11.041.68 Ø 12 ca.
Art. 11.041.69 Ø 14 ca.



H.1000 mm
Art. 11.041.70
□ 14 mm ca.

Smussato / Blunted



H.1000 mm
Art. 11.041.71
□ 14 mm ca.

Smussato / Blunted

400



Tutte le parti di questo catalogo - foto comprese - sono di proprietà Euro-Fer. La riproduzione, anche parziale, è vietata in ogni forma e con ogni mezzo. / Every part of this catalogue - photos included - is Euro-Fer's property. All forms of copying are strictly prohibited.

ELEMENTI IN FERRO FORGIATO E CAPISALDI
FORGED BARS AND POSTS



H.1000 mm
Art. 11.041.72
□ 12 mm ca.

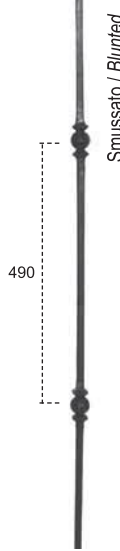

H.1000 mm
Art. 11.041.73
□ 12 mm ca.



H.1000 x L.120 mm
Art. 11.041.79
□ 14 mm ca.

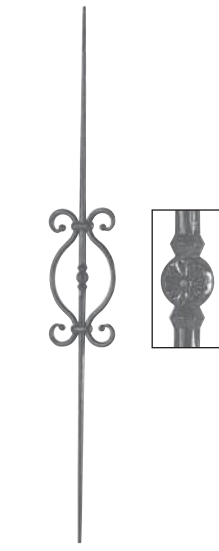

H.1000 X L.135 mm
Art. 11.041.80
Ø 14 mm circa



H.1000 X L.135 mm
Art. 11.041.81
Ø 14 mm circa

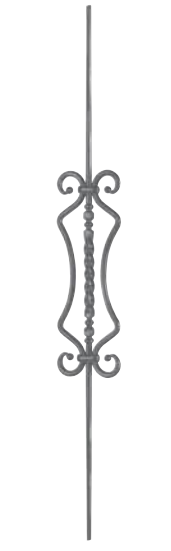

H.1000 X L.135 mm.
Art. 11.041.82
Ø 14 mm circa



H.1000 X L.135 mm.
Art. 11.041.83
Ø 12 mm circa



H.1000 X L.125 mm.
Art. 11.041.84
□ 14 mm circa



H.1000 X L.125 mm.
Art. 11.041.85
Ø 14 mm circa



H.1000 X L.125 mm.
Art. 11.041.86
□ 14 mm circa



Liscio / Smooth
H. 1000 mm
Art. 11.041.100 Ø 12 c.a.

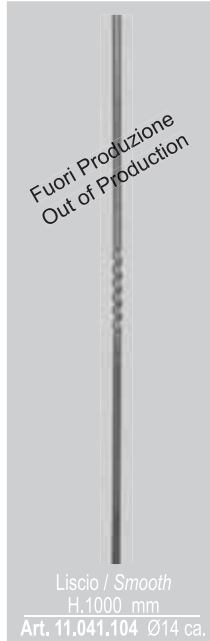

Liscio / Smooth
H.1000 mm
Art. 11.041.104 Ø14 ca.



Liscio / Smooth
H.1000 mm
Art. 11.041.105 Ø14 ca.

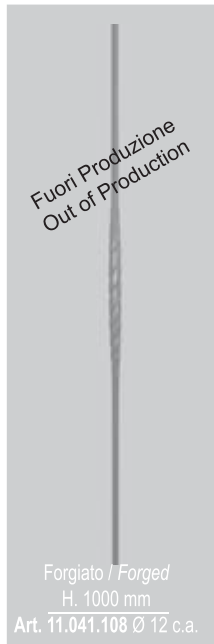

Forgiato / Forged
H. 1000 mm
Art. 11.041.108 Ø 12 c.a.



Forgiato / Forged
H.1000 mm
Art. 11.041.109 Ø 12 ca.



Forgiato / Forged
H.1000 mm
Art. 11.041.110 Ø 12 ca.



Forgiato / Forged
H.1000 mm
Art. 11.041.111 Ø12 ca.



Forgiato / Forged
H.1000 mm
Art. 11.041.113 Ø12 ca.

Tutte le parti di questo catalogo - foto comprese - sono di proprietà Euro-Fer. La riproduzione, anche parziale, è vietata in ogni forma e con ogni mezzo. / Every part of this catalogue - photos included - is Euro-Fer's property. All forms of copying are strictly prohibited.



Forgiato / Forged
H.1000 mm
Art. 11.041.115 Ø14
circa



Smussato / Blunted
H.1000 mm
Art. 11.041.118 □13 ca



Battuto / Beaten
H.1100 mm.
Art. 11.042 □ 20



Battuto / Beaten
H.1100 mm.
Art. 11.043 □ 25
Art. 11.044 □ 30



H.1100 mm.
Art. 11.044.01 □ 20



H.1100 mm.
Art. 11.044.02 □ 25
Art. 11.044.03 □ 30



H.1100 mm.
Art. 11.044.04 □ 20



H.1100 mm.
Art. 11.044.04 □ 20
Art. 11.044.05 □ 25
Art. 11.044.06 □ 30

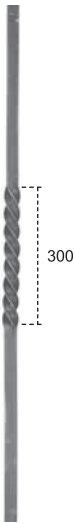

H.1200 mm.
Art. 11.044.07 □ 20
Art. 11.044.08 □ 25
Art. 11.044.09 □ 30



In Spigolo / Edged Bar
H.1200 mm.
Art. 11.045 □ 25
Art. 11.046 □ 30



H.1100 mm.
Art. 11.047 □ 20
Art. 11.048 □ 25
Art. 11.049 □ 30



Martellato / Hammered
H.1100 mm.
Art. 11.049.01 □ 20
Art. 11.049.02 □ 25
Art. 11.049.03 □ 30



Liscio / Smooth
H.1200 mm
Art. 11.049.08
Ø 25 circa



Forgiato / Forged
H. 1200 mm
Art. 11.049.11
□ 25 mm



Forgiato / Forged
H. 1200 mm
Art. 11.049.12
Ø 25 mm



In Spigolo / Edged Bar
H.1200 mm.
Art. 11.050 □ 25
Art. 11.051 □ 30



Martellato / Hammered
H.1100 mm.
Art. 11.052 □ 20
Art. 11.052.01 □ 25
Art. 11.052.02 □ 30



H.1100 mm.
Art. 11.053 □ 20
Art. 11.053.01 □ 25
Art. 11.053.02 □ 30



H.1200 mm.
Art. 11.053.03 □ 25
Art. 11.053.04 □ 30



H.1200 mm.
Art. 11.053.05 □ 25
Art. 11.053.06 □ 30

Tutte le parti di questo catalogo - foto comprese - sono di proprietà Euro-Fer. La riproduzione, anche parziale, è vietata in ogni forma e con ogni mezzo. / Every part of this catalogue - photos included - is Euro-Fer's property. All forms of copying are strictly prohibited.



Martellato / Hammered
H.1200 mm.
Art. 11.053.07 □ 25
Art. 11.053.08 □ 30

Tondo / Round
H.1200 mm.
Art. 11.053.09 Ø 25
Art. 11.053.10 Ø 30

H.1200 mm.
Art. 11.053.11 □ 25
Art. 11.053.12 □ 30

Martellato / Hammered
H.1200 mm.
Art. 11.053.13 □ 25
Art. 11.053.14 □ 30

Tondo / Round
H.1200 mm.
Art. 11.053.15 Ø 25
Art. 11.053.16 Ø 30

H.1200 mm.
Art. 11.053.17 □ 20
Art. 11.053.18 □ 25
Art. 11.053.19 □ 30

Martellato / Hammered
H.1200 mm.
Art. 11.053.20 □ 20
Art. 11.053.21 □ 25
Art. 11.053.22 □ 30

Tondo / Round
H.1200 mm.
Art. 11.053.23 Ø 25
Art. 11.053.24 Ø 30

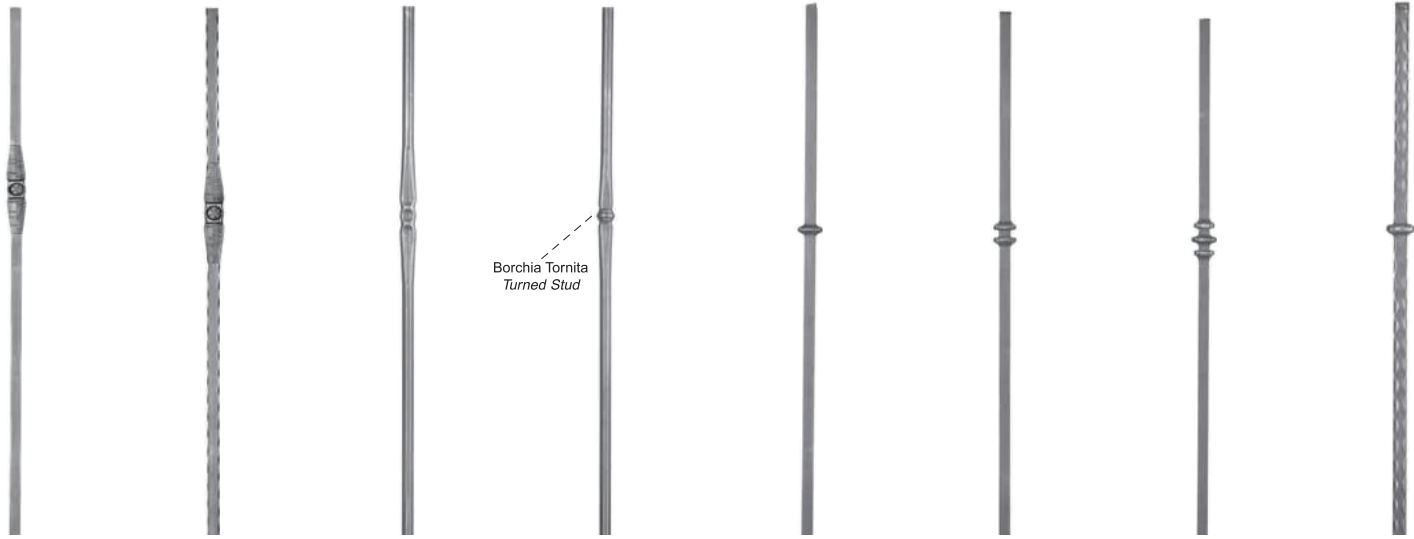

Borchia Tornita
Turned Stud

H.1200 mm.
Art. 11.053.25 □ 25
Art. 11.053.26 □ 30

Martellato / Hammered
H.1200 mm.
Art. 11.053.27 □ 25
Art. 11.053.28 □ 30

Tondo / Round
H.1200 mm.
Art. 11.053.29 Ø 25

Tondo / Round
H.1200 mm.
Art. 11.053.30 Ø 25

H.1200 mm.
Art. 11.053.31 □ 25
Art. 11.053.32 □ 30

H.1200 mm.
Art. 11.053.33 □ 25
Art. 11.053.34 □ 30

H.1200 mm.
Art. 11.053.35 □ 25
Art. 11.053.36 □ 30

Martellato / Hammered
H.1200 mm.
Art. 11.053.37 □ 25
Art. 11.053.38 □ 30

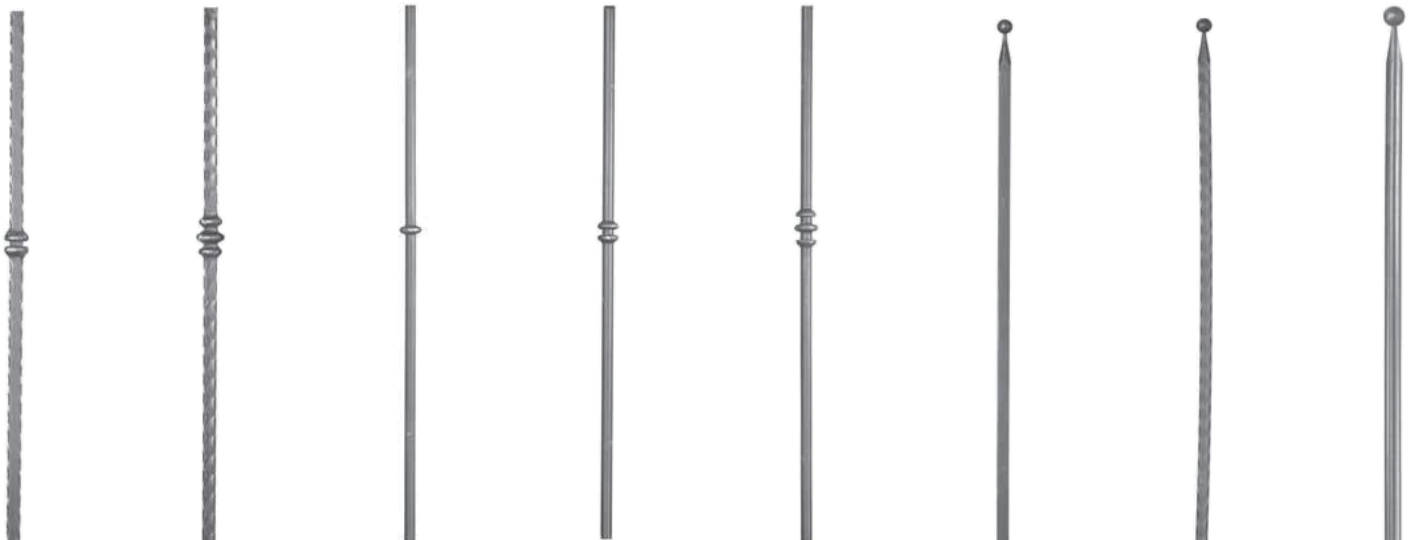

Martellato / Hammered
H.1200 mm.
Art. 11.053.39 □ 25
Art. 11.053.40 □ 30

Martellato / Hammered
H.1200 mm.
Art. 11.053.41 □ 25
Art. 11.053.42 □ 30

Tondo / Round
H.1200 mm.
Art. 11.053.43 Ø 25
Art. 11.053.44 Ø 30

Tondo / Round
H.1200 mm.
Art. 11.053.45 Ø 25
Art. 11.053.46 Ø 30

Tondo / Round
H.1200 mm.
Art. 11.053.47 Ø 25
Art. 11.053.48 Ø 30

H.1200 mm.
Art. 11.053.49 □ 25
Art. 11.053.50 □ 30

Martellato / Hammered
H.1200 mm.
Art. 11.053.51 □ 25
Art. 11.053.52 □ 30

Tondo / Round
H.1200 mm.
Art. 11.053.53 Ø 25
Art. 11.053.54 Ø 30

Tutte le parti di questo catalogo - foto comprese - sono di proprietà Euro-Fer. La riproduzione, anche parziale, è vietata in ogni forma e con ogni mezzo. / Every part of this catalogue - photos included - is Euro-Fer's property. All forms of copying are strictly prohibited.



H.1200 mm.
Art. 11.053.55 □ 25
Art. 11.053.56 □ 30

Martellato / *Hammered*
H.1200 mm.
Art. 11.053.57 □ 25
Art. 11.053.58 □ 30

Tondo / *Round*
H.1200 mm.
Art. 11.053.59 Ø 25
Art. 11.053.60 Ø 30

H.1200 mm.
Art. 11.053.61 □ 25
Art. 11.053.62 □ 30

Martellato / *Hammered*
H.1200 mm.
Art. 11.053.63 □ 25
Art. 11.053.64 □ 30



Tondo / *Round*
H.1200 mm.
Art. 11.053.65 Ø 25
Art. 11.053.66 Ø 30

Martellato / *Hammered*
H.1200 mm.
Art. 11.053.67 □ 25 circa
Art. 11.053.68 □ 30 circa

H. 1200 mm
Martellato / *Hammered*
Art. 11.053.69 □ 30x30
Art. 11.053.70 □ 25x25

Liscio / *Smooth*
H. 1200 mm
Art. 11.053.71 □ 30x30
Art. 11.053.72 □ 25x25
Art. 11.053.73 Ø 30
Art. 11.053.74 Ø 25

Liscio / *Smooth*
H.1200 mm
Art. 11.053.90
Ø 25 circa

H.1200 mm.
Art. 11.054
□ 25 circa

H.1200 mm.
Art. 11.055
□ 25 circa

H.1200 mm.
Art. 11.056
□ 25 circa



H.1200 mm.
Art. 11.057 □ 25 circa
Art. 11.058 □ 30 circa

H.1200 mm.
Art. 11.059 □ 25 circa
Art. 11.060 □ 30 circa

H.1200 mm.
Art. 11.059.P
□ 25 circa

H.1200 mm.
Art. 11.061 □ 25 circa
Art. 11.062 □ 30 circa

H.1200 mm.
Art. 11.063
□ 25 circa

H.1200 mm.
Art. 11.064
□ 25 circa

H.1200 mm.
Art. 11.065
□ 25 circa

H.1200 mm.
Art. 11.066
□ 25 circa

Tutte le parti di questo catalogo - foto comprese - sono di proprietà Euro-Fer. La riproduzione, anche parziale, è vietata in ogni forma e con ogni mezzo. / Every part of this catalogue - photos included - is Euro-Fer's property. All forms of copying are strictly prohibited.

ELEMENTI IN FERRO FORGIATO E CAPISALDI
FORGED BARS AND POSTS



H.1200 mm.
Art. 11.067
□ 25 circa



H.1200 mm
Art. 11.067.01
Ø 25 circa



H.1200 mm.
Art. 11.068
Ø 25 mm



H.1200 mm.
Art. 11.068.01
Ø 25 mm



H.1200 mm.
Art. 11.069
Ø 30 circa



H.1200 mm.
Art. 11.070
□ 25 mm



Smussato / Blunted
H.1200 mm
Art. 11.070.01
□ 25 mm ca.



H.1200 mm.
Art. 11.071
□ 25 mm



Forgiato / Forged
H.1200 mm
Art. 11.071.01
□ 25 circa



H.1200 mm.
Art. 11.072
Ø 25 mm



H.1200 mm.
Art. 11.073
□ 25 mm



Martellato / Hammered
H.1200 mm.
Art. 11.074
□ 25 mm



Liscio / Smooth
H.1200 mm.
Art. 11.075
Ø 25 mm



H.240 x L.200 mm
Art. 11.077.01 Ø 40 mm ca.



Tondo Lavorato / Round Hammered
H.1100 X L.400 mm.
Art. 11.077
Ø 30 mm



H.870 X L.480 mm.
Art. 11.078



H. 970 X L. 420 mm.
Art. 11.079



H.1100 x L.480 mm
Art. 11.080

Tutte le parti di questo catalogo - foto comprese - sono di proprietà Euro-Fer. La riproduzione, anche parziale, è vietata in ogni forma e con ogni mezzo. / Every part of this catalog - photos included - is Euro-Fer's property. All forms of copying are strictly prohibited.



H.160 mm.
Art. 11.100
□ 14 mm circa



H.160 mm.
Art. 11.101
□ 14 mm circa



H.160 mm.
Art. 11.102
Ø 12 mm circa



H.200 mm.
Art. 11.150
□ 24 mm circa



Forgiato / Forged
L.3000 mm.
Art.11.200 Ø 12 c.a.
Art.11.201 Ø 14 c.a.
Art.11.203 Ø 16 c.a.
Art.11.207 Ø 20 c.a.
Art.11.208 Ø 25 c.a.
Art.11.209 Ø 30 c.a.



Forgiato / Forged
L.3000 mm.
Art.11.210 □ 12 c.a.
Art.11.211 □ 14 c.a.



Rose Collection
CRYSTALS FROM
SWAROVSKI®

www.rosecollection.it